

TRONITEK LLC, Ekaterinburg, Russia



Multipurpose Transcutaneous Electrical Stimulator

DENAS[®] · PCM

Operating Manual

Россия/ Russia	<input checked="" type="radio"/>
ЕС, все страны/ EU, all	<input type="radio"/>
США/ USA	<input type="radio"/>
Канада/ Canada	<input type="radio"/>

ТРТК 04.4-03.71 РЭ
ТУ 9444-009-44148620-2009

Registration Certificate for medical device of the Federal Agency for Supervision of Health Care Service
№ ФСР 2009/06316.

CONTENTS

Part I. Technical Passport

1 Safety Rules.....	5
2 Purpose.....	10
3 Technical Parameters.....	11
4 Package Contents.....	24
5 Elements of the device.....	25
6 Sequences Using the Device.....	34
7 Using Menu.....	36
8 Maintenance.....	64
9 Battery Replacement Procedure.....	66
10 Troubleshooting.....	67
11 Manufacturer Warranty.....	72

Part II. Application instructions

1 Conducting treatment procedures.....	76
<i>Annex A. Accessories.....</i>	<i>101</i>
<i>Annex B.</i>	
<i>Zone Atlas for Using Programs Menu.....</i>	<i>107</i>
<i>Alphabetical Index of Programs.....</i>	<i>111</i>
<i>Alphabetical List of Diseases.....</i>	<i>112</i>
<i>Annex C.</i>	
<i>Zone Atlas for Using Frequency Menu.....</i>	<i>139</i>

PART I

Technical passport

4 **Thank you for buying DENAS-PCM device!**

For efficient and safe use of the device, it is necessary to read all the chapters of this Operating Manual.

1 SAFETY RULES



The information contained in this Operating Manual is important for your safety and correct use and maintenance of the device.



The device is safe in service as it uses low voltage current source isolated from the applied part (B type item with F type applied part).



It is not allowed to use the device for treatment of patients with implanted electronic devices (such as a heart pacemaker) or patients with idiosyncrasy of electric current.



It is prohibited to apply the device in direct projection of the heart in the front.

6



It is not advisable to connect the patient to any other high frequency electrical devices during the stimulation. Simultaneous application of the device with another electrical equipment may lead to burns or possible damage of the device.



If the device is used near short wave or microwave equipment, it may result in instability of the device output parameters.



It is prohibited to connect the device to any other devices except for external electrodes produced by the manufacturer.



It is prohibited to use external mains supply. Any partial or full dismantling of the device, as well as any modifications in the device are prohibited.



The device contains fragile elements. Keep it from blows.



Keep the device away from continuous direct sunlight at high ambient temperature (above 25 °C). Keep the device away from heating appliances.



The device is not waterproof. Keep it away from humidity.



Specialists qualified by the manufacturer only should perform any repair works of the devices. Any partial or full dismantling of the device, as well as any modification in the device are prohibited.

8

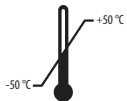

Transport Conditions: temperature of 50°C below zero to 50°C above zero, and atmospheric pressure of 70 to 106 kPa (525-to795 mm Hg).

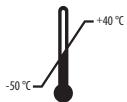

Storage Conditions: temperature of 50°C below zero to 40°C above zero, and atmospheric pressure of 70 to 106 kPa (525-to795 mm Hg).

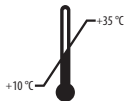

Operating Conditions: temperature of 10°C above zero to 35°C above zero, and atmospheric pressure of 70 to 106 kPa (525-to795 mm Hg).



Attention! *If the device has been stored at temperature 10°C below the ambient air temperature, leave it at a temperature of application environment for a minimum of two hours before using.*

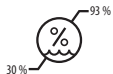

Relative air humidity of 30 to 93 %.

9



Waste Disposal: packaging materials do not have adverse impact on the environment; they could be recycled.



The device and batteries should be disposed of according to the established disposal rules for electronic devices.

The device contains valuable materials, which could be used after recycling subject to environment protection requirements. They should be taken to specialized waste collection and disposal centers (consult the relevant agencies at your region).

It is technically feasible to dispose of the device. The device does not pose any hazard to life or health of people or to environment after the expiry of its service (product) life and it does not require any special measures to prepare or send its components for disposing.

10 **2 PURPOSE**

DENAS-PCM Multipurpose Transcutaneous Electrical Stimulator is designed to exert general regulating impact on physiological systems of human body and to treat functional disorders of a wide range of illnesses. Application of electric current impulses on biologically active points and zones of human body perform dynamic electrical nerve stimulation. The device also allows to select an individual treatment program or to choose among the existing programs. The device has in-built electrode and a connector for external therapeutic electrodes*.

DENAS-PCM device can be used at healthcare centers and at home according to doctor's instructions.

* *The device should only be connected to external electrodes produced by the manufacturer (see Annex A).*

3 TECHNICAL PARAMETERS

3.1 Electrical impulses of the device have the following output parameters:

3.1.1 When load = 20 kOhm

Capacity (in standard units)	Minimum*	Maximum**
	1	99
Amplitude of phase 1, B	≤ 40	≤ 40
Duration of phase 1, ms	$6,0 \pm 1,5$	400 ± 100
Amplitude of phase 2, B	$9,0 \pm 2,5$	450 ± 113

* The above stated parameters apply to treatment mode impulses and do not apply to test impulses. Parameters should be measured when Therapy without Contact Control Function is enabled.

** Parameters should be measured when Children's Doctor Function is disabled.

12

3.1.2 Relation of the impulse shape to load resistance with medium and maximal capacity level.

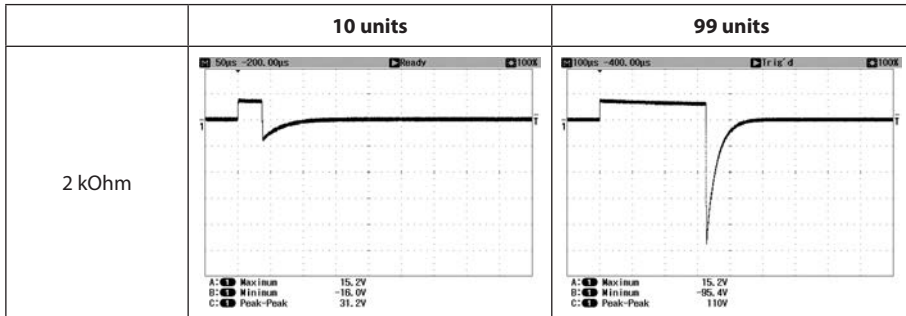

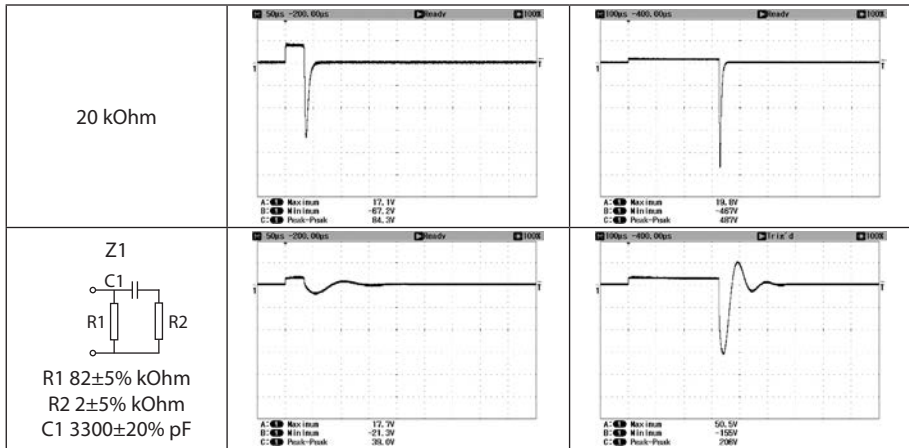

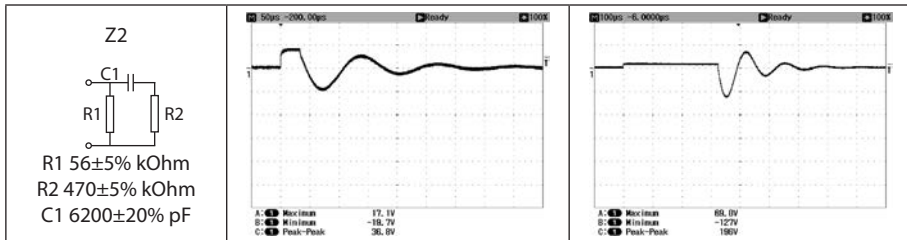

3.2 The device allows setting the following impulse frequencies, Hz:

3.2.1 Range 1: 1.0 to 9.9 with pitch of 0.1 ± 0.05 .

3.2.2 Range 2:

— 10 ± 1 , including MED (preventive treatment) and Screening modes and Programs Menu;

- 20 ± 2 ;
- 60 ± 2 ;
- 77 ± 3 ;
- 77 ± 3 and 10 ± 2 modulated with frequency of 2 ± 0.1 (frequency «7710»);
- 77 ± 3 with amplitude modulation (frequency «77AM»);
- 77 ± 3 ($2,0 \pm 1,0$ s) и 20 ± 2 ($3,0 \pm 1,5$ s) (frequency «7720»);
- 125 ± 4 ;
- 140 ± 5 ;
- 200 ± 5 .

3.3 Special stimulation programs.

Program name	Application zone / frequency / duration	Age
ALLERGY	Zone 1: «7710» (5 min) + 3,8 Hz (5 min) Zone 2: 77 Hz (5 min) + 1,7 Hz (5 min) + 3,8 Hz (5 min)	over 7 years
PAIN	Zone 1: Impulses with quasirandom repetition frequency charge with in the range of 75 to 135 Hz (15 min)	over 1 years

INTENSE PAIN	Zone 1: Impuls packets with repetition frequency of 77 Hz and variable duration and carrier frequency: from 2.5 msec and 27 kHz at minimum power level up to 1.0 msec and 2.8 kHz at maximum power level (15 min)	over 7 years
BLOATING	Zone 1: «7710» (5 min) + 125 Hz (5 min)	any age
DYSTONIA	Zone 1: «7710» (10 min) + 10 Hz (5 min) + 2,5 Hz (5 min)	over 4 years
GYNECOLOGICAL PAIN	Zone 1: «7710» (5 min) + 3,8 Hz (5 min) + 4,0 Hz (5 min)	over 13 years
GYNECOLOGY	Zone 1: 2,5 Hz (5 min) + 4,0 Hz (5 min) + 9,4 Hz (5 min) Zone 2: «7710» (15 min) Zone 3: 10 Hz (5 min) + 20 Hz (5 min)	over 13 years
HYPERTENSION	Zone 1: «7710» (5 min) Zone 2: «7710» (5 min)	over 7 years
HYPOTONIA	Zone 1: «77AM» (15 min)	over 7 years
HEAD	Zone 1: 60 Hz (5 min) Zone 2: 60 Hz (5 min) Zone 3: 60 Hz (5 min)	over 7 years

THROAT	Zone 1: 60 Hz (10 min) Zone 2: 77 Hz (10 min)	over 4 years
DIARRHEA	Zone 1: 125 Hz (10 min) Zone 2: 20 Hz (5 min)	any age
ABDOMINAL PAIN	Zone 1: «7710» (5 min) + 3,8 Hz (5 min) + 5,9 Hz (5 min)	over 4 years
CONSTIPATION	Zone 1: 125 Hz (10 min) Zone 2: 20 Hz (5 min)	any age
COUGH	Zone 1: «7710» (5 min) Zone 2: 60 Hz (10 min)	over 1 years
MUSCLES	Zone 1: Impuls packets with duration of 380 ± 38 msec, repetition frequency of 1 Hz, and carrier frequency of 125 Hz. The duration of the first phase of the impulse is variable (15 min)	over 1 years
COLD	Zone 1: 10 Hz (10 min) Zone 2: «7720» (10 min)	any age

POTENCY	Zone 1: 2,6 Hz (5 min) + 4,0 Hz (5 min) + 9,4 Hz (5 min) Zone 2: «7710» (15 min) Zone 3: 10 Hz (5 min) + 20 Hz (5 min)	over 13 years
KIDNEYS	Zone 1: 77 Hz (10 min) + 20 Hz (10 min) Zone 2: 2,8 Hz (5 min) + 8,1 Hz (5 min) + «7710» (5 min)	over 7 years
BACK	Zone 1: 140 Hz (5 min) + 77 Hz (5 min) + 20 Hz (5 min)	over 4 years
JOINTS	Zone 1: 140 Hz (5 min) + 77 Hz (5 min) + 20 Hz (5 min) + 1,6 Hz (5 min) Zone 2: «7710» (10 min)	over 7 years
NAUSEA	Zone 1: «7710» (10 min)	over 4 years
TRAUMA	Zone 1: 200 Hz (5 min) + 140 Hz (5 min) + 77 Hz (5 min)	over 1 years
ASPHYXIA	Zone 1: «7710» (10 min) Zone 2: 1,0 Hz (3 min) + 8,0 Hz (3 min) + 3,6 Hz (3 min)	any age

3.4 Maximum consumption current (with supply voltage of 3 V) is not more than 300 mA. 19

3.5 Power supply source: batteries of LR6/AA type, 2 pieces with voltage of 1.5 V. It is allowed to use the relevant storage batteries with voltage of 1.2 V*.

3.6 The device weighs not more than 0.35 kg.

3.7 The overall dimensions of the device are not more than 165×65×65 mm.

3.8 The device automatically switches off not later than 5 minutes after one of its keys (except for  key) has last been pressed, after the electrodes have been released from skin, or after the stimulation period has finished.

* Operation procedure (recharger types, recharge methods) is described in the storage battery instruction manual. Duration of the device service when used with storage batteries depends on characteristics of the batteries.

3.9 Electromagnetic Radiation

Test	Conformity to IEC 60601-1-2	Conditions of Use
Radio-frequency radiation CISPR 11	Class B	DENAS-PCM Electrical Stimulator can be used in all types of institutions and at home as well
	Group 1	DENAS-PCM emits very little radio-frequency radiation that cannot lead to failure of electronic equipment located nearby

3.10 Resistance to radio-frequency radiation.

Test	IEC 60601-1-2 test conditions	Acceptable level
IEC 61000-4-6	3 Vrms от 150 kHz до 80 MHz	3 Vrms
IEC 61000-4-3	3 V/m от 80 MHz до 2,5 GHz	3 V/m

3.11 Resistance to electromagnetic fields.

21

Magnetic fields	Test level	Conformity level	Conditions of Use
Electrostatic discharge (ESD) IEC 61000-4-2	±6 kV contact; ±8 kV air	±4 kV contact; ±8 kV air	The floor should be made of wood, concrete or ceramic tiles. If the floor is covered with synthetic material, the relative air humidity should be not less than 40%.
Magnetic fields IEC 61000-4-8	3 A/m	3 A/m	Magnetic field parameters should be within the normal values for commercial buildings and healthcare facilities.

- 22 **3.12** Recommendations for determining the necessary distance between DENAS-PCM Electrical Stimulator and radio equipment.

Label maximum output capacity of the transmitter P (W)	Radiation frequency and formula to determine the distance d (m)		
	150 kHz – 80 MHz $d = 1,2\sqrt{P}$	150 kHz – 800 MHz $d = 1,2\sqrt{P}$	800 MHz – 2,5 GHz $d = 2,3\sqrt{P}$
0,01	0,12	0,12	0,23
0,1	0,38	0,38	0,73
1	1,2	1,2	2,3
10	3,8	3,8	7,3
100	12	12	23

3.13 Conditions of Use.

3.13.1 Connection of external electrodes not-authorized by the manufacturer (including other cable length, cable type, electrode construction) may lead to increase

of electromagnetic radiation level and/or to reduction of resistance of the device to external effects.

23

3.13.2 DENAS-PCM device uses electromagnetic power for its internal functions only; therefore, the device emits minimum radiation and does not affect the electronic equipment located nearby.

3.13.3 Recommendations for User

Electrostatic discharge (ESD). User should not wear clothes made of synthetic materials during the treatment session.

Radio-frequency radiation. Personnel (User) should take the following safety measures: minimum distance from the device to mobile communicating devices (mobile phones, wireless phones) should 3 meters if the output capacity of these devices is more than 2 W.

4 PACKAGE CONTENTS

Description	Quantity
DENAS-PCM Electrical Stimulator	1
Operating Manual (RU)	1
Operating Manual (EN)*	1
Consumer packaging	1
Battery of LR6/AA type	2
Promo CD*	1

5 ELEMENTS OF THE DEVICE

25

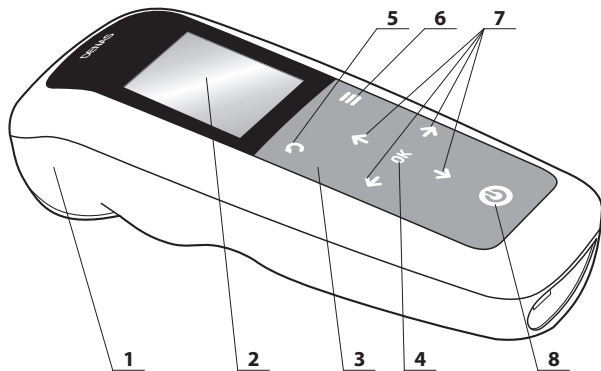

1. Body.
2. Display — LCD indicator.
3. Keyboard.
4. Select Menu Key (OK).
5. Previous Menu Key (←).
6. Reset Key (≡).
7. Navigation keys (↑ ↓ ← →).
8. On/Off Key (⏻).

Figure 1 — DENAS-PCM device (top view)

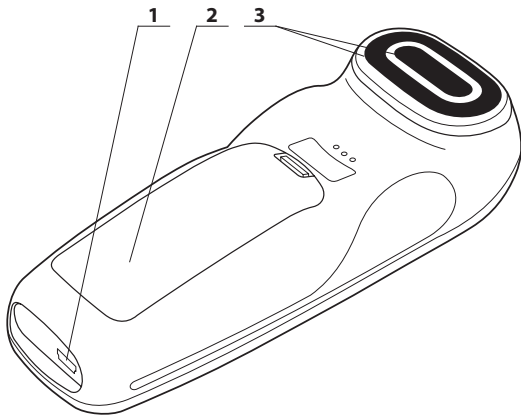

1. Connector for external electrodes (closed with protective cap).
2. Battery case lid.
3. In-built electrode.

Figure 2 — DENAS-PCM device (bottom view)

The device can be connected to external therapeutic electrodes of manufacturer's model range (see Annex A).

27



Attention! *External therapeutic electrodes can only be used for Frequency and Programs modes.*

In order to improve the contact you can moisture skin with water or with Malavtilin cream or with Baby-DENS cream for children before applying the electrodes.

28 **5.1** Indicator view in different modes.

5.1.1 Symbols and Main Menu items.

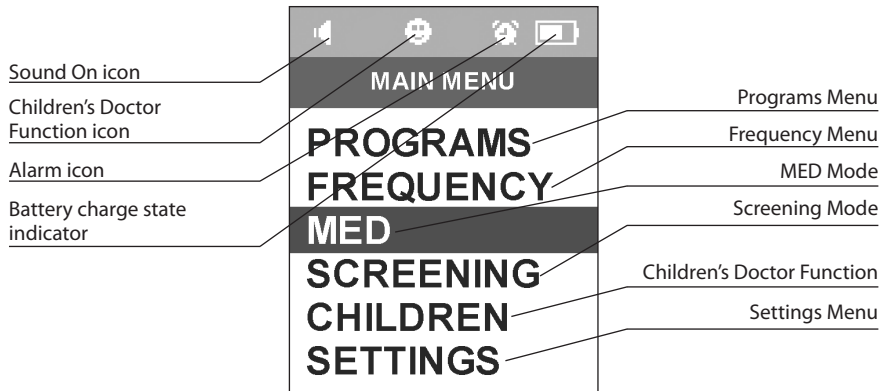

5.1.2 Timer setting.

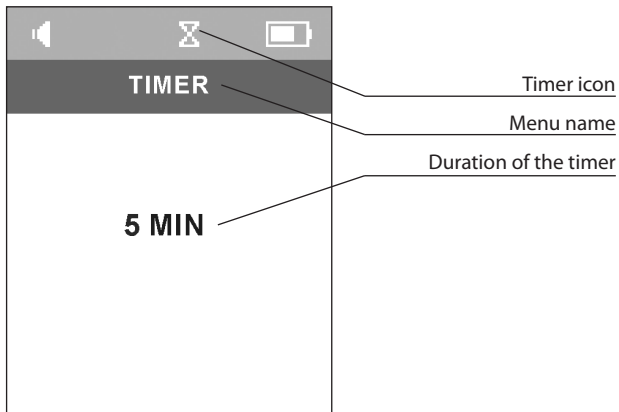

5.1.3 Clock and Alarm Clock Settings.

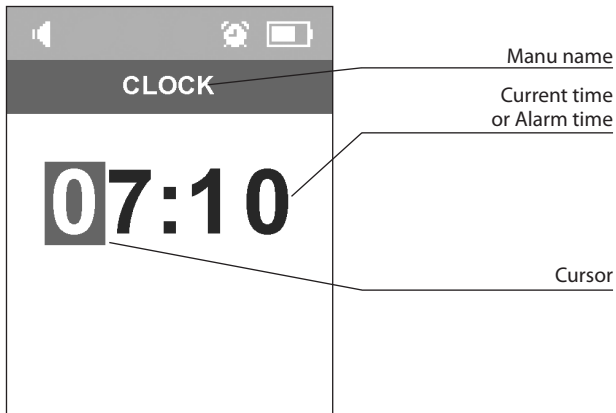

5.1.4 Stimulation Mode

31

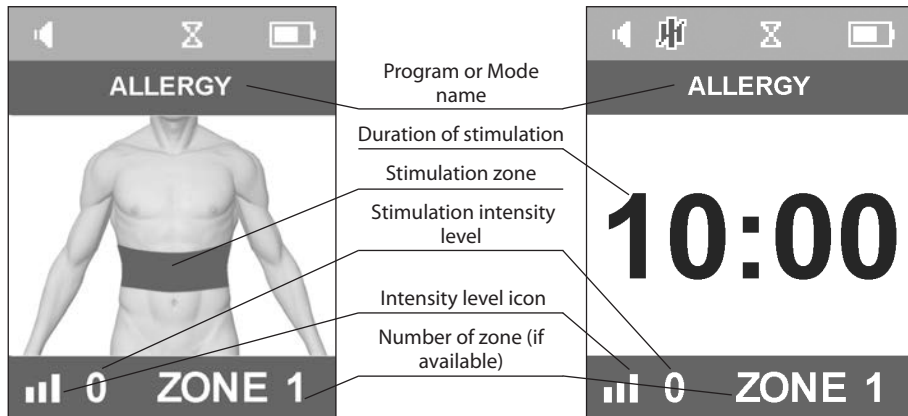

5.1.5 Intensity level settings

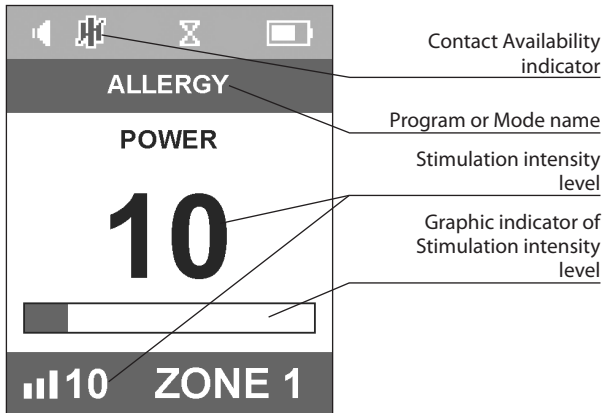

5.1.6 MED and Screening Modes

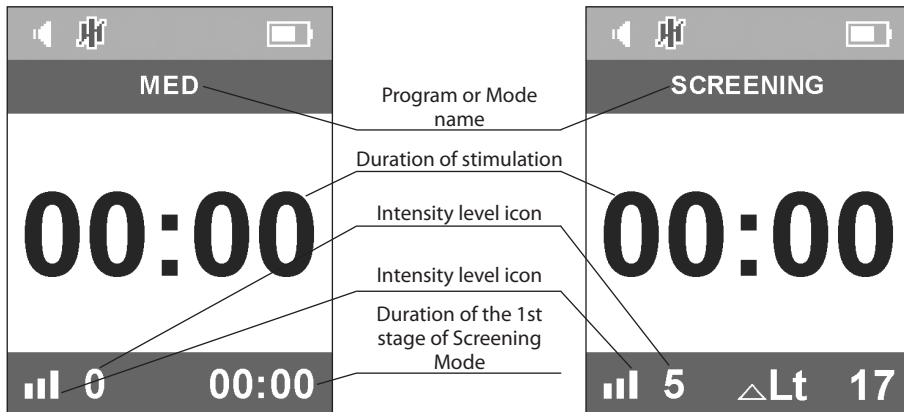

6 SEQUENCES USING THE DEVICE

6.1 Switching on.

Press key . After playing the sound signal and startup screen the device shows:

- Main Menu if Last Settings Recording Function is disabled;
- the last mode that was active when the device has been switched off if Last Settings Recording Function is enabled.

6.2 Selecting mode or function.

Use the navigation keys to select the necessary program, mode or function and press  to open it.

6.3 Returning to Menu.

In order to return to previous menu use key . In order to open Main Menu use key .

6.4 Switching off.

35





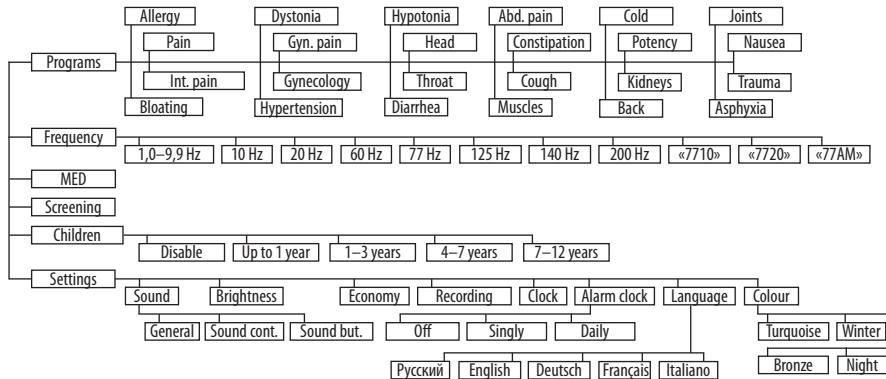

Press key  holding it down for 3 seconds. «Good Health» message will appear on the display and the device will switch off after the sound signal.



7 USING MENU





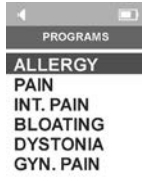

7.1 Menu Structure.









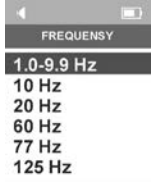

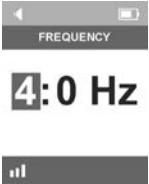

7.2 Selecting Menu items.





Programs Menu		
1	Use navigation  and  keys to select Programs in the Menu and confirm your choice by pressing  .	
1.1	Choose the necessary program by using  and  keys in the opened section.	

1.1.1	<p>The device will show the chosen mode. On the display will appear recommended zone for application.</p>	
1.1.2	<p>The device will show the chosen mode, for safety reasons electric stimulation will be at the minimum intensity level. Set the necessary intensity with ⏪ and ⏩ keys. Detailed description of the device operation in Programs mode is given in the Operating Manual, Part II, Application Instructions.</p>	

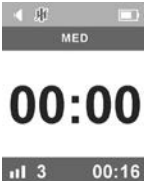





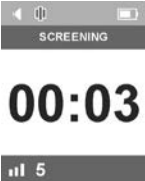





Frequency Menu		
2	Select Frequency in Main Menu by using  and  navigation keys and confirm your choice by pressing  .	
2.1	Choose the necessary frequency by using  and  keys in the opened section. Make your choice and press  .	







2.1.1	<p>If you choose infralow frequencies (1.0 – 9.9 Hz) the device will show the settings menu of infralow frequencies. Set the necessary frequency with navigation keys (set the integral value first, then the decimal value) and press  in order to confirm the selected frequency (see item 1.1.1).</p>	
2.1.2	<p>The device will show the chosen mode. Set the necessary intensity with  and  keys. Detailed description of the device operation in Programs mode is given in the Operating Manual, Part II. Application Instructions.</p>	







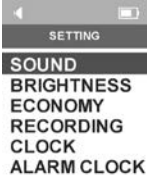

Minimum Effective Dose (MED)		
3	Select MED mode in Main Menu by using navigation keys  and  confirm your choice by pressing  .	 <p>MAIN MENU</p> <p>PROGRAMS FREQUENCY MED SCREENING CHILDREN SETTINGS</p>
3.1	The device will show MED mode. Set the necessary intensity with  and  keys. Detailed description of the device operation in MED mode is given in the Operating Manual, Part II. Application Instructions.	 <p>MED</p> <p>00:00</p> <p>3 00:16</p>



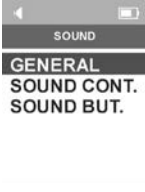





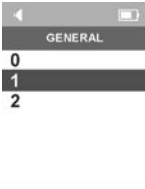







Screening Diagnostic Mode		
4	<p>Select Screening mode in the Main Menu by using  and  navigation keys and confirm your choice by pressing .</p>	
4.1	<p>The device will show Screening mode, electric stimulation will be at fixed intensity level. It is not possible to change the intensity in Screening mode.</p>	







4.2	<p>If you make measuring for the second time, the previous value will appear in the lower right corner.</p> <p>Detailed description of the device operation in Screening mode is given in the Operating Manual, Part II. Application Instructions.</p>	
-----	--	---

Children's Doctor Function		
5	<p>Select Children's Doctor section in Main Menu by using  and  navigation keys and confirm your choice by pressing .</p>	
5.1	<p>The device has a function of limiting the intensity for sessions with the children. Set the child's age by using  and  keys and confirm your choice by pressing . If you press  or  key instead of  key or if you power off the device, Children's Doctor settings will return to earlier saved settings. If Children's Doctor function is enabled,  symbol will appear in the status bar.</p>	

Sound Menu (Sound settings)		
6	<p>Select Settings section in Main Menu or Stimulation Window by using  and  navigation keys and confirm your choice by pressing . The number of items in SETTINGS menu depends on the current status of the device.</p>	 <p>MAIN MENU</p> <p>PROGRAMS FREQUENCY MED SCREENING CHILDREN SETTINGS</p>
6.1	<p>Select Sound in Settings Menu by using  and  keys and confirm your choice by pressing .</p>	 <p>SETTING</p> <p>SOUND BRIGHTNESS ECONOMY RECORDING CLOCK ALARM CLOCK</p>

6.1.1	<p>The device will show Sound Settings Menu: general device sound, skin contact sound, key pressing sound. Select one of the changeable parameters by using  and  keys and confirm your choice by pressing .</p>	
6.1.1.1	<p>The device has three volume levels for adjusting the general device sound: mute, minimal and maximal levels indicated as 0, 1 and 2 correspondently. Select one of the volume levels by using  and  keys and confirm your choice by pressing . If you press  or  key instead of  key or if you power off the device, Sound settings will return to earlier saved settings.</p> <p>Attention! <i>The volume of sound signals depends on the set volume level. If Mute level is set there will be no sound signals.</i></p>	

6.1.2.1	<p>The contact of electrodes with the skin can be confirmed with a sound signal under the relevant settings. Enable or disable this function by using  and  keys and confirm your choice by pressing . If you press  or  key instead of  key or if you power off the device, Sound settings will return to earlier saved settings.</p>	
6.1.3.1	<p>Navigation around the Menu can be accompanied with sounds. Enable or disable this function by using  and  keys and confirm your choice by pressing . If you press  or  key instead of  key or if you power off the device, Sound settings will return to earlier saved settings.</p>	
6.1.3.2	<p>Indication of volume level</p> <p> — Mute, level 0;</p> <p> — Volume on, level 1 or 2.</p>	

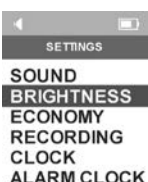





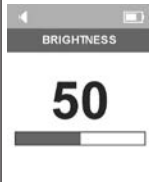

Brightness Menu (Display Brightness adjustment)		
6	Select Settings section in Main Menu by using  and  navigation keys and confirm your choice by pressing  .	
6.2	Select Brightness in Settings Menu by using  and  keys and confirm your choice by pressing  .	











6.2.1











The device has brightness adjustment option within the range of 5 to 100 with a pitch of 5. Select the comfortable brightness level using ← and → keys. And confirm your choice by pressing OK. If you press ↶ or ≡ key instead of OK key or if you power off the device, Brightness settings will return to earlier saved settings.

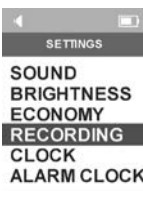







Attention! *If you use increased backlit brightness it may lead to increase of current consumption and earlier change of batteries. If you use the minimal backlit brightness, it will allow prolonging the service of the installed batteries.*











Economy Menu (Economical use of batteries)		
6	Select Settings section in Main Menu by using  and  navigation keys and confirm your choice by pressing  .	
6.3	Select Economy in Settings Menu by using  and  keys and confirm your choice by pressing  .	





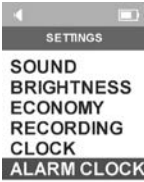



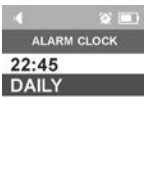







6.3.1	<p>The device will show Economy mode, which allows selecting Economical Use of Batteries function: activating lower energy consumption mode by reducing backlit duration (notwithstanding the set brightness level). Enable or disable this function by using  and  keys and confirm your choice by pressing . If you press  or  key instead of  key or if you power off the device, Economy Mode settings will return to earlier saved settings.</p>	
Last Settings Recording Menu (Recording of last settings)		
6	<p>Select Settings section in Main Menu by using  and  navigation keys and confirm your choice by pressing .</p>	





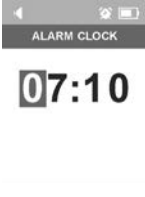

6.4	<p>Select Last Settings Recording in Settings Menu by using  and  keys and confirm your choice by pressing .</p>	 <p>Settings menu showing options: SOUND, BRIGHTNESS, ECONOMY, RECORDING, CLOCK, ALARM CLOCK.</p>
6.4.1	<p>The device will show Last Settings Back-up Menu. In this section, you can change status of the Last Settings Recording Function. If this function is enabled the device will switch on in the same treatment mode that was active when the device has last been switched off. If this function is disabled, the device will go into Main Menu after switching on. Enable or disable this function by using  and  keys and confirm your choice by pressing . If you press  or  key instead of  key or if you power off the device, Last Settings Recording settings will return to earlier saved settings.</p>	 <p>Recording menu showing options: DISABLE, ENABLE.</p>

Clock Menu (time adjustment)		
6	Select Settings section in Main Menu by using  and  navigation keys and confirm your choice by pressing  .	
6.5	Select Clock in Settings Menu by using  and  keys and confirm your choice by pressing  .	











6.5.1	<p>When setting the time you can set the current time, in order to do that set the cursor on the changed area by using ⬅️ and ➡️ keys, change the values in correspondence with their true values by using ⬆️ and ⬇️ keys and confirm your choice by pressing ⓄK. If you press ↶️ or ☰ key instead of ⓄK key or if you power off the device the current time values will not change.</p>	 <p>The screenshot shows a mobile device screen with a grey header bar containing a back arrow on the left and a battery icon on the right. Below the header, the word "CLOCK" is centered. The main display area shows the time "07:10" in a large, bold, black digital font.</p>
<p>Alarm Clock Menu (Alarm Clock Settings)</p>		
6	<p>Select Settings section in Main Menu by using ⬆️ and ⬇️ navigation keys and confirm your choice by pressing ⓄK.</p>	 <p>The screenshot shows a mobile device screen with a grey header bar containing a back arrow on the left and a battery icon on the right. Below the header, the words "MAIN MENU" are centered. A list of menu items is displayed: "PROGRAMS", "FREQUENCY", "MED", "SCREENING", "CHILDREN", and "SETTINGS". The "SETTINGS" item is highlighted with a dark grey background.</p>











6.6	Select Alarm Clock in Settings Menu by using  and  keys and confirm your choice by pressing  .	 <p>SETTINGS</p> <p>SOUND BRIGHTNESS ECONOMY RECORDING CLOCK ALARM CLOCK</p>
6.6.1	The device will show Alarm Clock Menu where you can set the periodicity of alarm clock signal and alarm clock time. Select one of the changeable items in the Menu by using  and  keys and confirm your choice by pressing  .	 <p>ALARM CLOCK</p> <p>22:45 DAILY</p>

6.6.1.1	<p>In order to set the periodicity of the alarm clock, use keys  and  to select one of operation modes: disabled, one time or every day. Press  to save the selected mode. If you press  or  key instead of  key or if you power off the device the current alarm clock settings will not change.</p> <p>If alarm clock is enabled,  symbol will appear in the status bar. In order to turn off the alarm clock when it goes off press  button one time.</p>	
6.6.2.1	<p>In order to set the signal time of the alarm clock, use keys  and  to set the cursor on the changeable area, and change the values according to the desired values by using  and  keys and confirm your choice by pressing . Switch off the device. If you press  or  key instead of  key or if you power off the device the current alarm clock settings will not change.</p>	

Language Menu	
6	Select Settings section in Main Menu by using  and  navigation keys and confirm your choice by pressing  .
6.7	Use  and  keys to select Language item in Settings Menu and confirm your choice by pressing  key.





6.7.1	<p>The user interface of the device is available in five languages: Russian, English, German, Italian, and French. Use  and  keys to select the necessary language in Language Menu and confirm your choice by pressing  key. If you press  key or  instead of  key or you turn off the power, the language setting will return to the previously saved one.</p>	
Colour Menu		
6	<p>Select Settings section in Main Menu by using  and  navigation keys and confirm your choice by pressing .</p>	











6.8	Use  and  keys to select the Colour item in Settings Menu and confirm your choice by pressing  key.	
6.8.1	The user interface of the device is available in four colour themes: Turquoise, Winter, Bronze, and Night. Use  and  keys to select the necessary colour theme in Colour Menu and confirm your choice by pressing  key. If you press  key or  instead of  key or you turn off the power, the colour setting will return to the previously saved one.	

Contact Menu (Therapy without Contact Control Function is available for Programs and Frequency modes only except for Muscles Program)

7

Contact Menu allows operating Therapy without Contact Control Function, which makes it possible to generate electrical impulses notwithstanding the quality of contact or whether the electrodes contact the skin. When Therapy without Contact Control Function is enabled, the device does not produce any signal if electrodes stop contacting the skin. Therapy without Contact Control Function can be enabled by using navigation keys in Stimulation Window (Programs, Frequency). Select Contact Menu in Stimulation Window (Programs, Frequency) by using  and  keys and confirm your choice by pressing  key.





7.1	<p>The device will show Contact Menu . Enable or disable this function by using  and  keys and confirm your choice by pressing  key. If you press  key instead of  key in order to close Therapy without Contact Control Function its settings will not change.</p>	 <p>The screenshot shows a mobile-style interface with a back arrow on the left and a battery icon on the right. The title bar says 'CONTACT'. Below it, there are two large, bold options: 'OFF' and 'ON'.</p>
	<p>Contact status indication:</p> <ul style="list-style-type: none">  indication is on without interruption – electrodes contact the skin, Therapy without Contact Control Function is disabled;  electrodes do not contact the skin; it is recommended to slightly moisture the skin for better contact or to enable Therapy without Contact Control Function;  indication flashes on and off – Therapy without Contact Control Function is enabled. 	





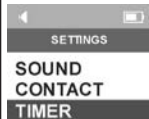

Timer Menu

8

Timer Function is necessary when it is not possible to control the time of stimulation (in case of electrical stimulation of hard-to-reach zones) or when the time of stimulation is strictly specified. When this function is enabled the stimulation time will be counted in the form of a countdown timer. When this function is disabled the maximum session time is 30 minutes. Timer function settings are available in Frequency Menu. The time in Programs, MED, and Screening Menus is fixed.

Use  and  navigation keys to select Timer item and confirm your choice by pressing  key.



8.1	<p>The device will show Timer Menu. Use  and  keys to set the desired timer value from 1 to 30 minutes (with pith of 1 minute) and confirm your choice by pressing . If you press  key instead of  key in order to close the timer its settings will not change. If timer is set on 0 minutes this function will be disabled and there will be direct timing of sessions in stimulation modes.</p> <p>If Timer function is ON it will appear symbol  in status bar.</p>	
-----	---	---

8 MAINTENANCE

8.1 Daily maintenance includes the following operations:

- visual inspection of the device;
- disinfection of electrodes.

Use standard disinfection means (such as 3% penozone) and soft napless diapers for cleansing of electrodes.

8.2 Operability of the device is checked according to recommendations stipulated in Section 6.

8.3 If you are supposedly not going to use the device for a long time, remove the set of batteries from the battery case (see Section 9).

8.4 If the battery symbol flashes and the device generates intermittent alarm sound it is necessary to replace the set of batteries of the device (see Section 9).



Attention! *If the batteries are removed from the device for more than 5 minutes, User's individual settings and any set reminders will clear off and information about current time will be lost as well.*

9 BATTERY REPLACEMENT PROCEDURE

Replacement of the set* of batteries:

- open the battery case (1) and remove the batteries;
- place new batteries** respecting the polarities (2);
- close the battery case (3).

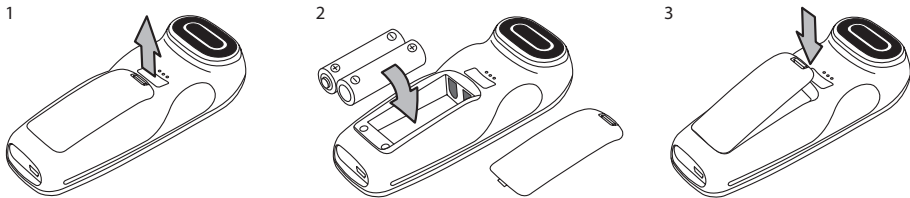

* The set consists of two batteries.

** Place only those batteries, which are designed for this type of the device: LR6/AA type with nominal voltage of 1.5 V or relevant storage batteries with nominal voltage of 1.2 V.

10 TROUBLESHOOTING

Defect	Probable reason	Remedy
1) The device does not switch on after pressing the key 	Batteries are missing	Place a new set of batteries (see Section 9, Battery Replacement Procedure)
	Voltage of the set of batteries is less than 2.1 V	Replace the set of batteries (see Section 9, Battery Replacement Procedure)
2) After switching on, the device produces sound signals and automatically switches off	Voltage of the set of batteries is less than 2.1 V	Replace the set of batteries (see Section 9, Battery Replacement Procedure)
	The interval between the device switching on and its subsequent switching off is less than 3 seconds	Leave the device when off for a minimum of 3 seconds and then switch it on again

3) The device does not provide electrical stimulation when in-build electrode contact the skin.	No electric stimulation mode has been selected.	Open Programs or Frequency Menu and select the necessary electrical stimulation mode.
	The contact area of the in-build electrode with the skin is not sufficient.	Press the electrode tightly to the skin. Slightly moisten the skin if necessary.
	Zero intensity level is set.	Increase the intensity level.
4) The device does not produce sound signals (mode switching on, change of intensity level, end of the mode, etc.).	Sound is switched off.	Increase volume. Go to Settings → Sound → General.

5) The device does not provide electrical stimulation when external electrode are used.	No electrical stimulation mode has been selected.	Open Programs or Frequency Menu and select the necessary electrical stimulation mode.
	The contact area of the external electrode with the skin is not sufficient.	Press the external electrode tightly to the skin. Slightly moisten the skin if necessary.
	Zero intensity level is set.	Increase the intensity level.
6) Indicator backlit fades very fast.	Economical Use of Batteries Function is enabled.	Disable Economical Use of Batteries Function. Go to Settings → Economy.
7) The device does not automatically switches off when the electrode stop contacting the skin or when the device has not been used for more than 5 minutes.	Therapy without Contact Control Function is enabled.	Disable Therapy without Contact Control Function (see item 7.2.7 Contact Menu).

8) The device switches off or battery symbol flashes and the device produces intermittent alarm sound during the operation.	Voltage of the set of batteries is less than 2.1 V.	Replace the set of batteries (see Section 9, Battery Replacement Procedure).
9) The device does not switch on in time set for Alarm Clock.	Alarm Clock is Off.	Switch on the Alarm Clock. Go to Settings → Alarm Clock → Off and select One time or Daily mode.
	Voltage of the set of batteries is less than 2.1 V.	Replace the set of batteries (see Section 9, Battery Replacement Procedure).
10) The device switches off without command.	Voltage of the set of batteries is less than 2.1 V.	Replace the set of batteries (see Section 9, Battery Replacement Procedure).

11) Fast consumption of batteries.	Low-quality batteries.	Use high-quality batteries (it is recommended to use alkaline batteries) or storage batteries of relevant typical size with voltage not less than 1.5 V.
	Maximal backlit brightness level.	Reduce backlit brightness. Go to Settings → Brightness.
	Economical Use of Batteries Function is disabled.	Enable Economical Use of Batteries Function. Go to Settings → Economy.
12) The device does not provide intensity more than 5 units.	Children's Doctor Function is enabled.	Disable Children's Doctor Function (see item 7.2 Children's Doctor Function).
13) The Programs Menu lacks Gynecologic Pain, Gynecology, Potency.	Children's Doctor Function is enabled.	Disable Children's Doctor Function (see item 7.2 Children's Doctor Function).



Attention! Any other defects should be remedied by the company-manufacturer.

11 MANUFACTURER WARRANTY

11.1 The manufacturer guarantees that the device complies with Technical Regulation TY 9444-009-44148620-2009 on condition that it is used subject to operation, transportation and storage requirements.

11.2 Product service life is 5 years. The product service life for the designated purpose can exceed the period stipulated by the manufacturer considerably if consumer follows all the stipulated operation, transportation and storage requirements.

11.3 Product warranty period is 12 months after sale.

11.4 If any defects are found within the warranty period the seller (manufacturer) undertakes to satisfy the consumer's claim subject to Law of the Russian Federation On Protection of Consumers' Rights.

The seller (manufacturer) or any organization performing functions of the seller (manufacturer) under the relevant contract will not be responsible for any defects if they

emerge after the product has been delivered to consumer and relate to:

- 1) violation of operation, transportation and storage requirements stipulated hereto by consumer;
- 2) mechanical damages;
- 3) actions of third parties;
- 4) force-majeure circumstances.

11.5 Product warranty is not valid for the products which sealing marks have been broken.

11.6 If any defect is found within the Product Warranty period or if the delivered device is incomplete, owner of the product should send the product and a request for repair (replacement) to the manufacturer's address or its representative and indicate their full name, address, phone number, date and give short description of the defect and conditions under which it has emerged.

74 ***Manufacturer:***

TRONITEK LLC

Academika Postovskogo Str. 15,
Ekaterinburg, Russia, 620146

Tel./fax: +7 (343) 267-23-30

✉ corp@denascorp.ru

info@denasworld.com

PART II

Application Instructions

1 CONDUCTING TREATMENT PROCEDURES

1.1 General Information.

Stimulation of reflexogenic zones and points with impulse current for prevention, treatment and recovery of body functions is an efficient method of health improvement. Transcutaneous dynamic electrical nerve stimulation, which can be applied both together with other treatment methods and as a separate health improvement method, promotes positive dynamics of treating many acute and chronic diseases. Using of the device enhances recovery process, reduces pharmacological load on the body and promotes fast health improvement. Clinical research authentically established that transcutaneous dynamic electrical nerve stimulation is efficient for treating patients with cardiovascular disorders, locomotor system diseases, injuries, gynecological and urological diseases. It showed efficiency of treatment patients after surgeries, or with ophthalmologic problems, bronchopulmonary and gastrointestinal diseases. We have an extensive experience of using DENS for a wide range of neurological diseases. A series of studies evidence indisputable

advisability of dynamic electrical nerve stimulation as an effective component of combination treatment and rehabilitation programs in pediatrics. 77

1.2 Indications and contraindications for application.

The device can be used by patients of any age starting the newly born children. Subject to treatment purposes, the device can be used for analgesic, spasmolytic, vascular, anti-inflammatory, trophic, and general tonic effects.

1.2.1 Indications:

- acute and chronic pain syndromes;
- injuries;
- diseases and disorders of respiratory and gastrointestinal organs, ENT, and cardiovascular, musculoskeletal, nerve, endocrine, and genito-urinary systems, and eyes and skin;
- rehabilitation after diseases, surgical interventions, and injuries;
- enhancement of adaptive capacities of the body against pressures of negative

pathogen factors, intensive physical and mental stress, physical and mental exhaustion, and chronic fatigue syndrome; when it is hard for the patient to wake up in the morning and he/she feels drowsiness during the day, or he/she has disorder of falling asleep at night or insomnia; when there is hyperirritability, depression, or sexual function disorder, and for prevention of cold-related diseases.

1.2.2 Contraindications for application

Absolute:

- idiosyncrasy of electric current;
- implanted heart pacemaker.

Relative:*

- status epilepticus;
- availability of neoplasms of any etiology and location; in case of later stage of

* *In such cases, it is recommended to consult your doctor before using the electrical stimulator.*

oncological disease, electrical stimulation can be used as palliative (supporting) method for lessening pain syndrome, should be used on doctor's orders;

- acute fever of unknown etiology;
- venous thrombosis;
- acute psychological stress or alcoholic or drug intoxication.



Attention! *It is prohibited to apply the device in direct projection of the heart in the front.*

1.3 Conditions for Treatment Sessions.

No special conditions for treatment needed. You can conduct the sessions on your own or with the help of an operator who will stimulate those zones and points which cannot be reached and treated on one's own. During the electrical therapy session, patient may sit or lie in a comfortable position. Patient should rest for 10 to 15 minutes after the session.



Attention! *Disinfect electrode of the device with standard disinfection solution (such as 3% penozone) after session. Make sure that the electrode of the device is dry when storing.*

1.4 Treatment with the Device.

1.4.1 Treatment Methods.

Treatment is performed with stimulation of reflexogenic zones of different areas and biologically active points with the in-built electrode of the device or the relevant external therapeutic electrodes. There are three methods of stimulation: stable, instable and stable/instable.

1.4.1.1 Stable Method.

With this method, electrodes stay fixed on the selected zone during the whole stimulation session. It can be used for stimulation of small zones and biologically active points. This method can also be used for treatment of bigger zones when there is risk to damage the skin. In that case, electrodes are consequently applied on the next area of the skin.

1.4.1.2 Instable Method.

With this method, electrodes are moved around the zone selected for stimulation. Make smooth movements sliding the body surface with speed of 0.5 to 2–3 cm per second. Make straight, round or other movements applying slight compression depending on the size and relief of the stimulated zone.

1.4.1.3 Stable/Instable Method.

With stable/instable method, in-built or external zonal electrodes are applied and kept for a short period of time on the selected zones, for example, on the most painful zones.

1.4.2 Exposure Time.

When treatment session is conducted for emergency aid (for example, for pain relief), the main criteria to assess sufficiency of treatment during the session when pain disappears or the patient has fewer complaints.

In case of course treatment, when patient's condition stabilizes you can follow the average stimulation time values listed below.

- 82 Average duration of one session according to patient's age:
- for children under 1 year old — 5–10 minutes (1–3 minutes per one zone);
 - for 1–3 years old children — 10–15 minutes (3–5 minutes per one zone);
 - for 3–5 years old children — 15–20 minutes (5–7 minutes per one zone);
 - for 1–12 years old children — 20–25 minutes (7–9 minutes per one zone);
 - for children above 12 years old and adults — up to 30–40 minutes (10–15 minutes per one zone).

1.4.3 Stimulation Intensity.

Intensity of electrical stimulation is determined on individual basis according to patient's subjective feelings. Stimulation Intensity can be divided into three conventional levels.

1.4.3.1 Minimal level — there is no sensation or there is sensation of light vibration under the electrodes. Select minimal level if stimulation should have low intensity: for children under 12 years old and adults with cardiovascular diseases (arterial hypertension, arterial hypotension, vegetal dystonia). Those patients who suffer from frequent headaches or

giddiness should also start treatment setting the minimal intensity level. The device has special Children's Doctor Function for the above-mentioned categories of patients which provides minimal intensity level: 1 to 5 units.

1.4.3.2 Comfort level — sensations are above the sensitivity threshold. There is painless vibration, prickly sensation or light burning sensation under the electrodes. This intensity level is used more often.

1.4.3.3 Maximal level — sensations are on the sensitivity threshold. There is painful burning or prickly sensation under the electrode. Muscles of the stimulated zone may jerk. It can be applied for treatment of pain syndromes with intensive pain.



Attention! *Electrical stimulation level may be increased or decreased as patient's individual sensitivity changes or his/her pain reduces at different treatment stages.*



Attention! *Control the intensity level according to patient's sensations. It is not advisable to exceed the tolerance threshold.*









Attention! *Patients suffering from arterial hypertension, arterial hypotension, vegetal dystonia syndrome, frequent headaches or giddiness should have treatment at minimal intensity level.*

1.4.4 Stimulation Modes.

The device menu contains the following programs designed for treatment: Programs, Frequency, MED, and Screening.

1.4.4.1 Programs.

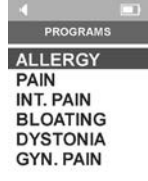
Sequences Using the Menu	
Use  and  keys to select Programs in Main Menu and press  .	
Select the necessary program by using  and  keys and press  .	

Apply the electrodes on the necessary zone. Set the necessary stimulation intensity by using ⬅️ and ➡️ keys and start treatment. Detailed description of using Programs is given in Annex A.

Attention! *Timer Function is not available in Programs.*









Programs Menu.						
<input checked="" type="checkbox"/> — The programme is available in the menu for this age. <input type="checkbox"/> — The programme is absent in the menu for this age.						
Program Name	Stimulation Zone	< 1 years	1-3 years	4-7 years	7-12 years	adult
ALLERGY	Upper abdomen				+	+
	7th cervical vertebra area				+	+
PAIN	Painful area		+	+	+	+
INTENSE PAIN	Painful area		+	+	+	+
BLOATING	Anterior abdominal wall	+	+	+	+	+
DYSTONIA	Neck and collar area			+	+	+
HYPERTENSION	2nd cervical vertebra area				+	+
	7th cervical vertebra area				+	+

HYPOTONIA	Neck and collar area				+	+
HEAD	2nd cervical vertebra area					
	Neck and collar area				+	+
	Hands, head area according to Su Jok					
THROAT	Hands, head area according to Su Jok			+	+	+
	Submaxillary area					
GYNECOLOGICAL PAIN	Painful abdominal area					+
GYNECOLOGY	Soles					
	Neck and collar area					+
	Lumbosacral area					
DIARRHEA	Anterior abdominal wall	+	+	+	+	+
	Lumbosacral area					
ABDOMINAL PAIN	Painful abdominal area			+	+	+

CONSTIPATION	Anterior abdominal wall	+	+	+	+	+
	Lumbosacral area					
COUGH	Submaxillary area		+	+	+	+
	Suprasternal notch					
MUSCLES	Injured or painful area		+	+	+	+
COLD	Hands, nose area according to Su Jok	+	+	+	+	+
	Nose alae and sinuses projections					
POTENCY	Lumbosacral area					+
	Neck and collar area					
	Soles area					
KIDNEYS	Lumbosacral area				+	+
	Soles area					

BACK	Spine projection, painful area			+	+	+
JOINTS	Painful joint					
	Segmental area				+	+
NAUSEA	Upper abdomen, right and left hypochondriums			+	+	+
TRAUMA	Injured part of the body		+	+	+	+
ASPHYXIA	Suprasternal notch					
	7th cervical vertebra area	+	+	+	+	+

1.4.4.2 Frequency

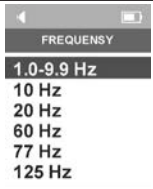
Sequences Using the Menu	
Use  and  keys to select Frequency in Main Menu and press  .	
Select the necessary program by using  and  keys and press  .	

The device is ready for treatment session. Apply the electrodes on the stimulation zone. Select the necessary stimulation intensity level by using ⬅️ and ➡️ keys and start treatment. Detailed information relating to selection of zones, intensity and time of stimulation is given in Annex B of this Instructions.

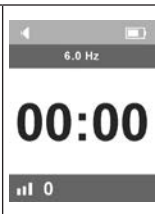





Administration of Treatment Modes	
Mode, Frequency, Hz.	Intended Use
1,0...9,9	<p>Frequency range of 1.0–4.0 Hz is used for direct stimulation of lymphoid, bone and connective tissues.</p> <p>Frequency range of 4.0 up to 7.0 Hz is used for direct stimulation of autonomic nervous system.</p> <p>Frequency range of 7.0 up to 9.9 Hz is used for correction of parenchymatous organs functioning.</p>
10 and 20	<p>Due to their universal curative effects, frequencies of 10 Hz and 20 Hz can be used for a wide range of illnesses and diseases in acute and rehabilitation period. They can be used for general tonic effect, stabilization and enhancement of curative effects of other frequencies when there are diseases of internal organs or locomotor system.</p>

60 and 77	Frequencies of 60 Hz and 77 Hz are universal and can be widely used for correction of internal organs disorders when there are expressed local complaints. They can be recommended for pain relief, improvement of local and regional blood flow, treatment of inflammations, etc. in acute and rehabilitation period.
125 and 140	Frequency of 125 Hz and 140 Hz can be recommended for treatment of locomotor system diseases and neuralgic pain accompanied with expressed pain syndrome.
200	Frequency of 200 Hz can be recommended for quick pain relief when there are locomotor system diseases, neuralgic pain, or injuries.
7710	7710 Frequency is recommended for people with symptoms of arterial hypertension, vegetal dystonia syndrome of hypotonic type, and patients with sleep disorders.
77AM	77AM Frequency can be recommended when there are symptoms of hypotonic or atonic state of internal organs.
7720	Frequency is recommended for dystonia symptoms control and reducing of puffiness.

1.4.4.3 MED

Minimal Effective Dose (MED) is an automatic program which can be used for rehabilitation and prevention when there is physical stress, psychic and emotional overstrain, chronic fatigue syndrome or internal organs diseases, or for prevention of cold-related diseases in epidemic season. It is used minimum once a day for a course of 8–12 days.

Sequences Using the Menu	
Use  and  keys to select MED in Main Menu and press  .	

Place the electrodes on Qigong area and set the stimulation intensity by using ← and → keys. It is recommended to set minimal or comfort intensity level.

Attention! Stimulation when using MED Program should be performed with in-built electrode only.

Attention! When the device is operated in MED mode, electrode should be kept stable on the patient's skin i.e. it is not allowed to move the electrodes of the device during its operation.





Attention! Control the intensity level according to patient's subjective sensations of electrode contacting the skin. It is not advisable to exceed the tolerance threshold.

MED Program consists of two phases. The device provides sound signal at the end of each phase.



1.4.4.4 Screening

Screening Mode allows choosing optimal stimulation zones in order to enhance systemic impact of DENS and to define latent trigger zones (obscure problem zones) by comparing how electrical parameters of skin change subject to stimulation of different parts of the selected zone.

Sequences Using the Menu	
Use  and  keys to select Screening in Main Menu and press  .	

The device is ready for operation. For getting started, apply the electrodes on the skin. The device will start operating when the electrodes contact the skin. The device automatically sets frequency (10 Hz) and stimulation intensity.

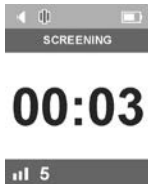

At the end of screening (after 5 seconds) the device will show the measured value on the display (Δ Lt). Write down or memorize the measured value. Place the device on the next zone in order to continue measuring.





Attention! *When the device is operated in Screening mode, electrode should be kept stable on the patient's skin i.e. it is not allowed to move the electrode of the device during its operation.*

When the device detects that electrodes contact the skin, 5 seconds indication will appear during which the device measures variation of skin electrical impedance to impulses of the device. After 5 seconds the device provides a short sound signal and displays the result of measuring in the form of LT index (in the range of 0 to 100 units), for example, $LT = 8$.

Write down the measured value. Apply the device on the next zone detaching the electrode of the device from skin for a maximum of 1–2 seconds. Latent trigger zones are those parts of the skin where LT values considerably change both upwards and downwards. For example, after testing adjoining parts of the selected skin zone you have received the following LT results (units): 6, 5, 8, 20, 4, 7. The latent trigger zone in this example is the zone with $LT = 20$. The found trigger zones should be additionally stimulated in Therapy mode with frequency of 60 Hz or 77 Hz during 1 to 5 minutes.

Handwriting practice area consisting of 12 horizontal dashed lines.

ANNEX A

Accessories

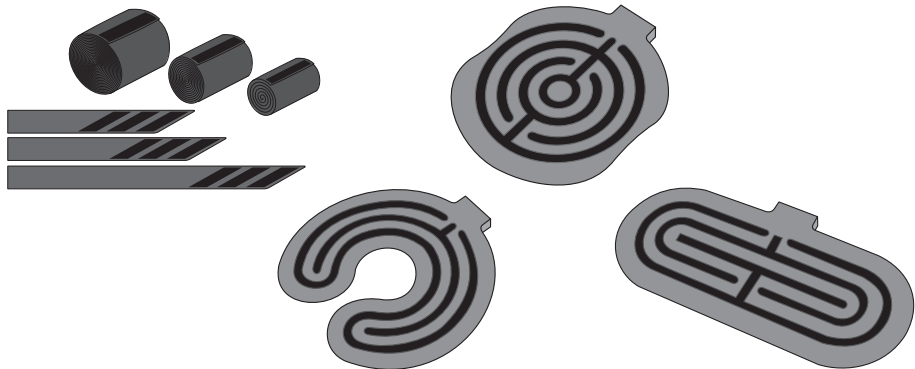

External zonal therapeutic electrodes.

Designed for therapeutic non-invasive treatment of pains, lesion focuses, and stimulation of reflexogenic zones (where skin is not damaged).

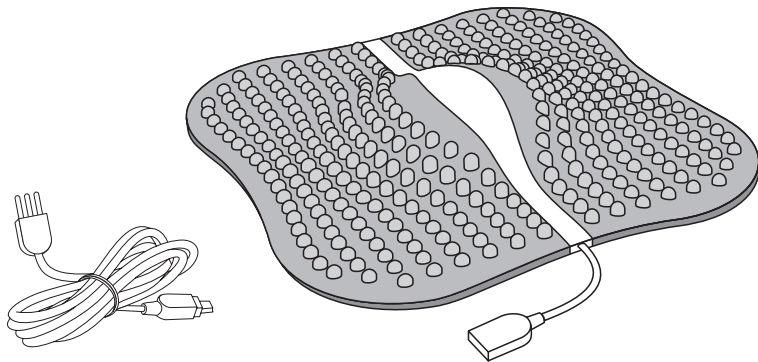

DENAS-Reflexo, external therapeutic electrode for feet.

Designed for stimulation of reflexogenic zones of plantar surface of the foot.

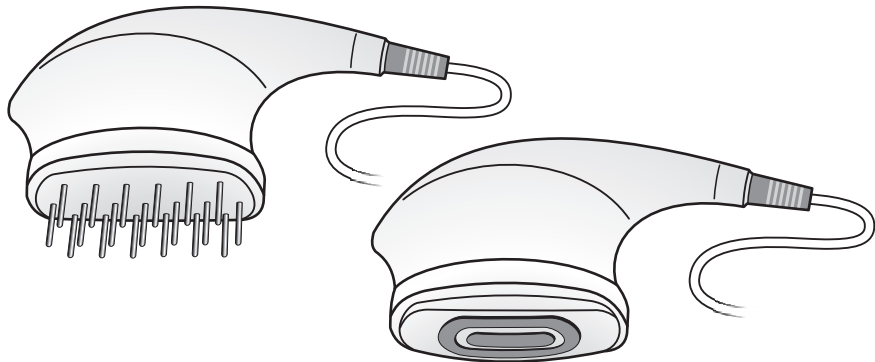

External therapeutic massage electrodes.

Designed for treatment of pains, lesion focuses, and stimulation of reflexogenic zones and acupuncture points of the body.

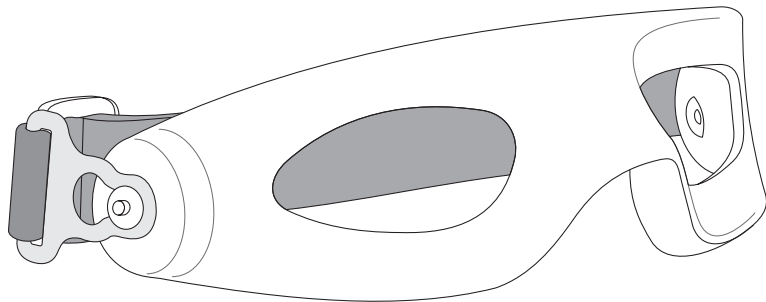

DENAS-Glasses, external therapeutic paraorbital electrode.

Designed for preventive and therapeutic non-invasive stimulation of biologically active points located around eyes in paraorbital area.

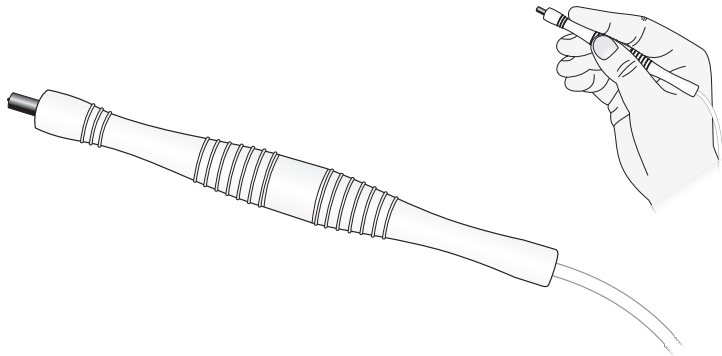

External therapeutic point electrode.

Designed for stimulation of biologically active points.

ANNEX B

Zone Atlas
for Using Programs Menu



Attention! *This Manual contains zones and modes of the common illnesses and diseases. You can find additional information about treatment and prevention capacities of dynamic electrical nerve stimulation devices in Practical Guidance for Electrical Nerve Stimulation.*

Select a disease or a symptom from the alphabetical list. Open the relevant Atlas chapter. You can use Frequency Menu for treatment of any disease from the alphabetical list. You can also use Programs menu for the most of diseases.

For treatment by using Frequency mode, apply the device on one of the zones indicated in the Atlas (there can be several stimulation zones depending on disease). Select time and intensity of stimulation. After finishing stimulating one selected zone, start treatment of the next recommended zone.

For treatment by using Programs mode, apply the device on one of the zones indicated in the Atlas (there can be several stimulation zones depending on disease). Set the stimulation intensity, treatment session will start. If the program includes stimulation of the second zone, the device will produce a sound signal after the necessary time and show the corresponding message on the display. Apply the device on the next zone and continue stimulation. If the program includes stimulation of the third zone, the device will produce a sound signal after the necessary time and show the corresponding message on the display. Place the device on the third zone and continue stimulation.



Attention! *The treatment methods described in the Atlas are given for reference only and they cannot substitute a consultation with a medical specialist.*

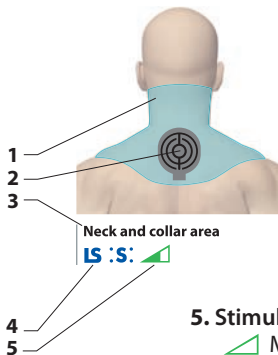

 1. Zone of stimulation with the in-built electrode

 2. Area for applying external zonal electrode

3. Zone of stimulation

4. Treatment method (see item 4.1 on page 13)

L Instable

LS Stable/Instable

S Stable

:S: Stable with applicator electrode

5. Stimulation intensity level / Patient's sensations (see item 4.3 on page 16)

 Minimal / No sensations

 Comfort / Pleasant prickly sensation

 Maximal / On the sensitivity threshold

Abdominal pain.....	127	Diarrhea.....	126	Joints.....	135
Allergy.....	115	Dystonia.....	118	Kidneys.....	133
Asphyxia.....	138	Gynecological pain.....	120	Muscles.....	130
Back.....	134	Gynecology.....	121	Nausea.....	136
Bloating.....	119	Head.....	124	Pain.....	116
Cold.....	131	Hypertension.....	122	Potency.....	132
Constipation.....	128	Hypotonia.....	123	Throat.....	125
Cough.....	129	Intense pain.....	117	Trauma.....	137

112 Alphabetical List of Diseases

Abdominal pain.....	125, 153	Bloating.....	119, 152	Diarrhea.....	126
Acute respiratory diseases.....	125, 143	Bone fracture (pain).....	137	Diskogenic radiculopathy.....	117, 134
Algodismenorrhea (Gyne- cological Pain).....	120, 177	Bronchial asthma.....	147	Dystonia.....	118
Allergy.....	115, 181	Bronchitis.....	129, 145	Eczema.....	181
Angina, tonsillitis.....	125, 149	Burns.....	116, 137, 167	Edema.....	201
Arterial hypertension.....	122, 197	Cardialgia.....	195	ENT diseases.....	131, 143
Arterial hypotension.....	123, 199	Caugh.....	129	Esthetics.	
Arthritis, arthrosis (joints).....	135, 161	Cataract.....	205	Facial care.....	183, 185
Astigmatism.....	205	Cellulite, obesity.....	185	Eye overstrain.....	195
		Constipation.....	128	Face pain.....	116, 189
		Coronary heart disease.....	195	Fever.....	213
		Dermatitis.....	181	Frequent and painful urination.....	169
		Diabetic angiopathy.....	203		

Giddiness.....	187	Lactation insufficiency (hypogalactia).....	121	Menstrual disorder.....	121
Glaucoma.....	205	Lactational mastitis.....	175	Myocardiodystrophy.....	195
Headache.....	124, 193	Logoneurosis, stammering.....	191	Nasal stuffiness.....	131, 143
Headache, vasoneurosis.....	118, 187	Long sight.....	205	Nausea.....	136
Heartache.....	195	Loss of consciousness.....	211	Neck pain and backache.....	134, 215
Heavy legs.....	116, 215	Loss of hearing.....	151	Nephrocolica.....	116, 117
Hemorrhoids.....	159	Lumbar pain.....	134, 215	Neurodermatitis.....	181
Hypertension.....	122, 197	Lumbolgia.....	117	Neurosis, sterss, vasoneurosis.....	118
Infertility (gynecology).....	121, 132	Male sex function disorder.....	132	Osteoarthritis (Joints) Arthritis, artrosis.....	135, 161
Insomnia.....	193	Maxillary sinusitis.....	143, 217	Otitis.....	116, 151
Ischias, lumbodynia.....	117			Pain in the joints.....	116, 135
Joint dislocation.....	165				

114 Alphabetical List of Diseases

Plugged duct.....	175	Short sight.....	205	Trauma.....	137
Prostatitis.....	132, 179	Sore throat.....	149	Trifacial neuralgia.....	189
Pyelonephritis.....	133	Stammering.....	191	Varicose veins, chronic venous insufficiency syndrome.....	201
Refringence disorder.....	215	Stress.....	118, 193	Wound, injury (trauma).....	137, 167
Rhinitis, cold.....	143	Tension of ligaments.....	165		
Sensorineural hearing loss.....	151	Toothache.....	117, 217		
		Tracheitis.....	125, 145		

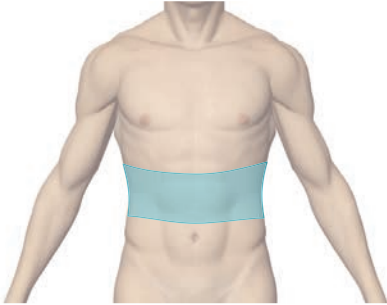

Zone 1. Upper abdomen, right and left hypochondriacums

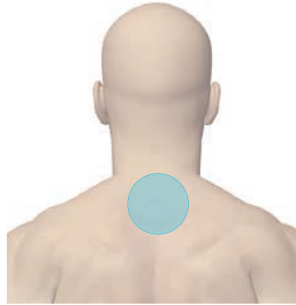

Zone 2. 7th cervical vertebra area



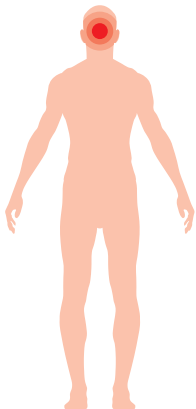

Zone: Painful area. The most painful area should be stimulated with in-built or external electrodes

LS :S: 

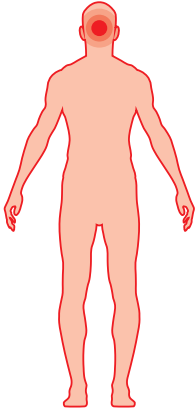

Zone: Painful area. The most painful area should be stimulated with in-built or external electrodes

LS  – intense pain

 – dull nagging ache



Zone: neck and collar area

LS :S: 

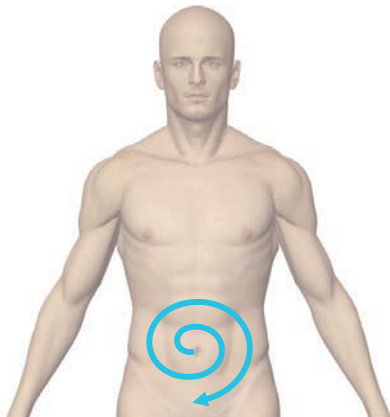

**Zone: Anterior abdominal wall.
Apply clockwise**



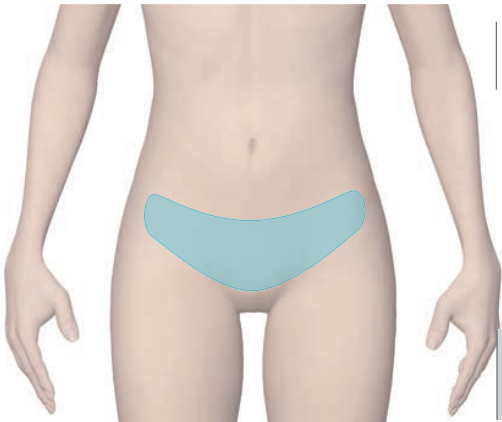

Zone: Lower abdomen



! *Attention!* Gynec. Pain Program is not available if Children's Doctor Function is enabled.

**Zone 1. Feet****Zone 2. Neck and collar area****Zone 3. Lumbosacral area**

Attention! The program is not available if Children's Doctor Function is enabled.



Zone 1. 2nd cervical vertebra area

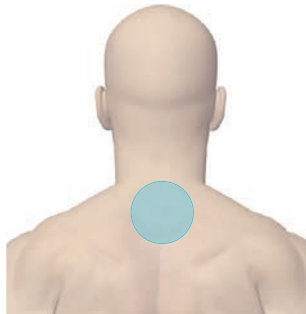

Zone 2. 7th cervical vertebra area





Zone: neck and collar area





**Zone 1. 2nd cervical
vertebra area**



**Zone 2. Neck and collar
area**



**Zone 3. Head project according
to Su Jok**





Zone 1. Hands, neck area according to Su Jok



Zone 2. Submaxillary area



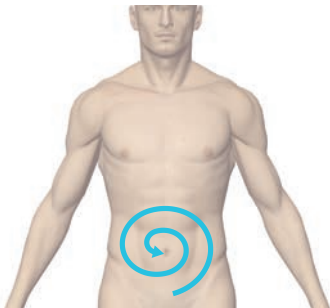

Zone 1. Anterior abdominal wall.
Apply counter-clockwise

LS :S: 



Zone 2. Lumbosacral area

LS :S: 

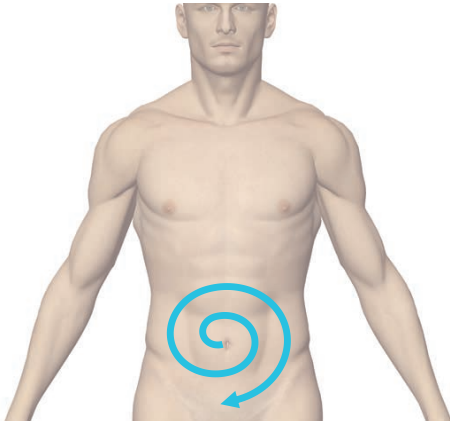

Zone: Painful area. Apply clockwise.

LS :S: 



Zone 1. Anterior abdominal wall.
Apply clockwise



Zone 2. Lumbosacral area





Zone 1. Submaxillary area



Zone 2. Suprasternal notch



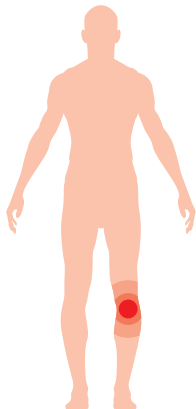

Zone: Painful and injured areas. The most painful area should be stimulated with in-built or external electrodes





**Zone 1. Hands, face and nose areas
according to Su Jok**

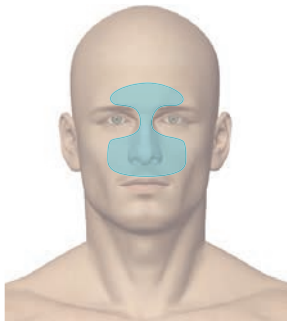

**Zone 2. Nose alae and sinuses
projection**



**Zone 1. Lumbar and sacral area****Zone 2. Neck and collar area****Zone 3. Feet**

Attention! The program is not available if Children's Doctor Function is enabled.



Zone 1. Lumbo-sacral area



Zone 2. Feet



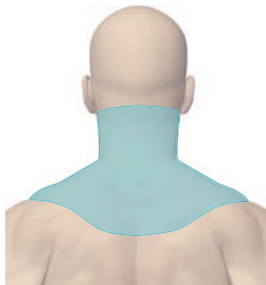

Neck pain — cervical spine: in case of intense pain, dull nagging pain

LS

— intense pain



— dull nagging ache

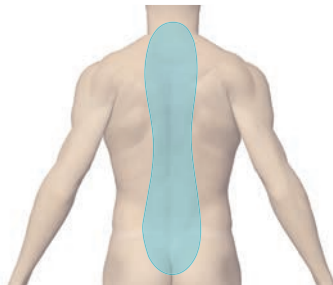

Backache — thoracic spine, lumbar spine, sacral spine

LS

— intense pain



— dull nagging ache

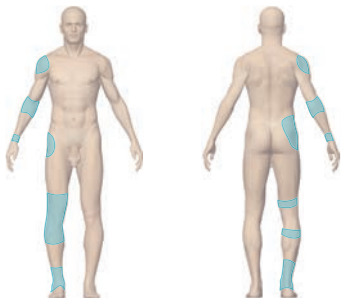

Zone 1. Painful joint

LS :S: 

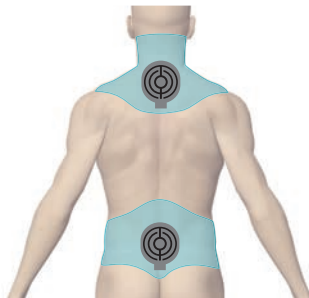

Zone 2. Lower back – if leg and feet joints are painful; neck and collar area – if arm and hand joints are painful

LS :S: 

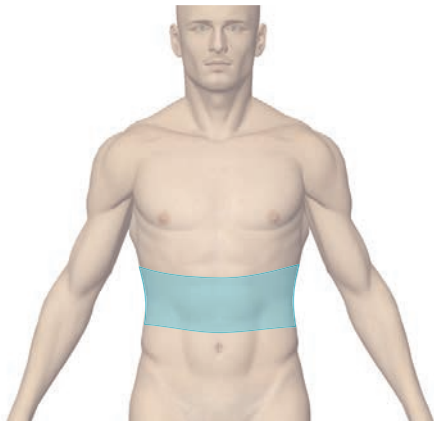

**Zone: Upper abdomen, right and left
hypochondriums**



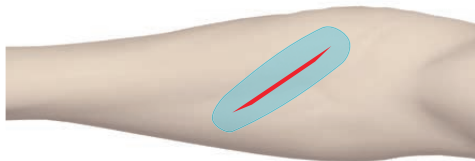

Zone: Apply around the injured part

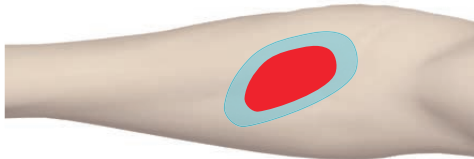



Zone 1. Suprasternal notch

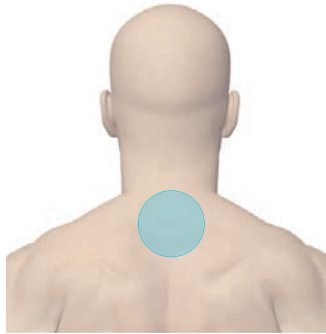

Zone 2. 7th cervical vertebra area



ANNEX C

Zone Atlas
for Using Frequency Menu



Attention! *The treatment methods described in the Atlas are given for reference only and they cannot substitute a consultation with a medical specialist.*



Attention! *Due to predefined parameters the Programs can be used for adults and children above 12 years old.*

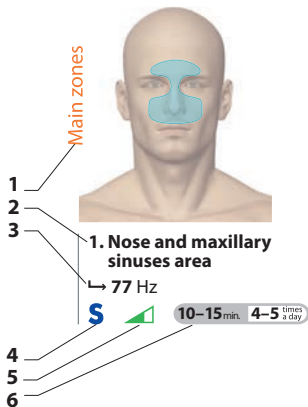

1. Main zones are designated for obligatory stimulation. **Additional zones** are stimulated in order to enhance the impact of treatment.

2. Consequence of zones stimulation

3. Mode selection in the device menu

- ↳ 77 Hz
- ↳ or other modes

4. Treatment method (see item 1.4.1, pages 82-83)

- L** Instable
- S** Stable
- LS** Stable/Instable
- :S:** Stable **with applicator electrode**

5. Stimulation intensity level / Patient's sensations

- ▴ Minimal / No sensations
- ▴ Comfort / Pleasant prickly sensation.
- ▴ Maximal / On the sensitivity threshold

6. Duration of treatment

- 10-15 min. 4-5 times a day Stimulate the zone during 10 to 15 minutes 4-5 times a day.

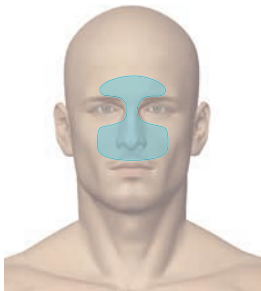

1. Nose and maxillary sinuses area

↳ 77 Hz

S



5–15 min. 4–5 times a day



2. Submaxillary area

↳ 77 Hz

S



5–15 min. 4–5 times a day



3. Neck and collar area

↳ 77 Hz

:S:



10–15 min. 1–2 times a day



1. Area according to Su Jok

↳ 3,6 Hz

S



5 min.

1-2 times a day

Note. Course duration — until full recovery



2. Qigong area

↳ 77 Hz

S



5-10 min.

1-2 times a day



1. Suprasternal notch

↳ 77 Hz

S  5–10 min. 4–5 times a day

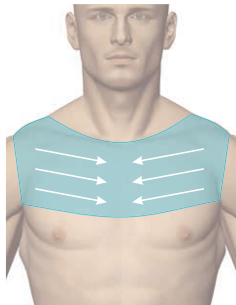

2. Lungs front projection

↳ 77 Hz

LS  5–15 min. 4–5 times a day



3. Lungs back projection

↳ 77 Hz

LS  5–15 min. 1–2 times a day

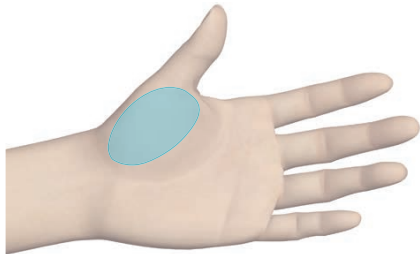

1. Area according to Su Jok

↳ 77 Hz

S



5 min.

1-2 times a day

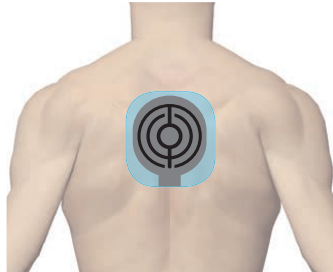

2. Area between the shoulder blades

↳ 10 Hz

:S:



5-10 min.

1-2 times a day

Note. Course duration — until full recovery

**1. Suprasternal notch**

↳ 77 Hz

S

5-10 min.

In case of asthma attack

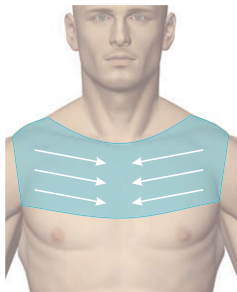
**2. Lungs front projection**

↳ 77 Hz

LS

5-10 min.

In case of asthma attack

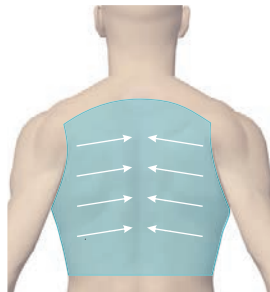
**3. Lungs back projection**

↳ 77 Hz

LS

5-10 min.

In case of asthma attack

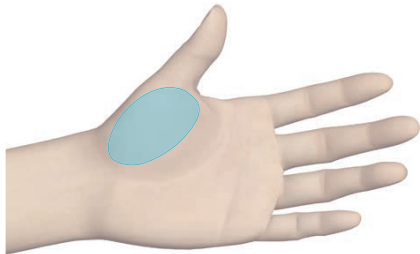
**1. Area according to Su Jok**

↳ 10 Hz



5 min.

In case of asthma attack

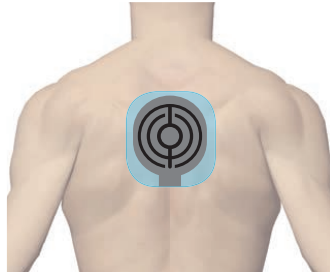
**2. Area between the shoulder blades**

↳ 77 Hz



5-10 min.

In case of asthma attack

Note. If one session is not enough repeat the session. Continue stimulation until the attack stops.



1. Suprasternal notch

↳ 77 Hz

S



5–10 min. 3–4 times a day

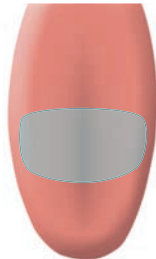

2. Tongue

↳ 77 Hz

S



1 min. 3–4 times a day



3. Submaxillary area

↳ 77 Hz

S



5–10 min. 3–4 times a day



1. Area according to Su Jok

↳ 77 Hz, 3-6 Hz

S  5 min. 2-3 times a day

Note. Course duration — until full recovery.



2. Neck and collar area

↳ 10 Hz

:S:  5-10 min. 1-2 times a day

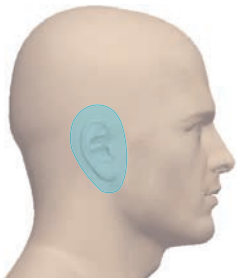

1. Ears and area around ears

↳ 77 Hz

S



10–15 min.



2. Neck and collar area

↳ 10 Hz

:S:



10–15 min.

In case of otitis, conduct stimulation 3-4 times a day, in case of sensorineural hearing loss – once a day



1. Area according to Su Jok

↳ 77 Hz

S



5–10 min.

In case of otitis, conduct stimulation 1-2 times a day, in case of sensorineural hearing loss — once in 2-3 days.

Additional zones

Note. Course duration in case of otitis — until full recovery. Course duration in case of sensorineural hearing loss — 10–14 days. Retreatment in 1–1.5 months.

Main zones

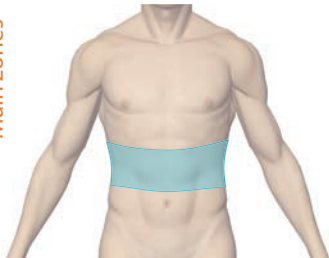

1. Stomach and pancreas gland projection

↳ 77 Hz

LS



5–10 min.

Stimulation 3–4 times a day until symptoms abate.

2. Thoracic section (at stomach level)

↳ 10 Hz

:S:



10–15 min.

Stimulation 3–4 times a day until symptoms abate.



1. Area according to Su Jok

↳ 77 Hz, 9,4 Hz

S



5 min.

1-2 times
a day

Note. Course duration — until full recovery.

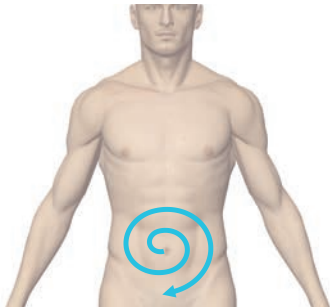

1. Anterior abdominal wall

↳ 77 Hz



10–15 min. in the morning



2. Lumbosacral area

↳ 10 Hz, «7710»



10–15 min. in the morning



1. Liver front and side projections.

↳ 77 Hz, 9,4 Hz

S



5-10 min.

1

time
a day

Additional zones

Note. Course duration — 7-10 days.

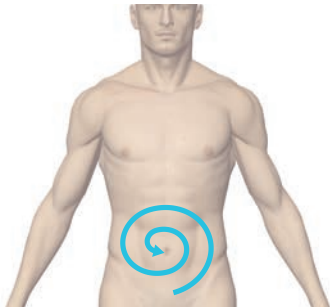

1. Anterior abdominal wall

↳ 77 Hz



10–15 min. 3–4 times a day



2. Lumbosacral area

↳ 10 Hz



10–15 min. 3–4 times a day



1. Liver front and side projections.

↳ 77 Hz



5 min.

1–2 times
a day

Additional zones

Note. Course duration — 10–14 days.

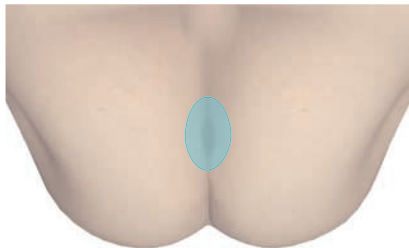

1. Periproctical area

↳ 77 Hz

S  5–10 min.

Several times a day as the patient's complaints increase.



2. Lumbosacral area

↳ 10 Hz

:S:  10–15 min.

Several times a day as the patient's complaints increase.



1. Area according to Su Jok

↳ 77 Hz, 9,4 Hz

S



5 min.

1-2 times a day

Additional zones

Note. Course duration — until recovery, but for a minimum of 7 days.



Pain in the joints (arthritis, arthrosis)

Main zones

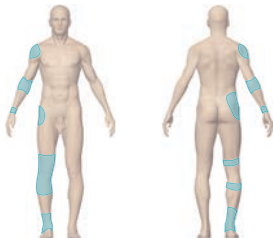

1. Painful joint area

↳ 77 Hz, 140 Hz

LS

5–10 min. 2–3 times a day

▲ — intense pain

▲ — dull nagging ache



2. **Neck and collar area** if arm and hand joints are painful.

Lumbosacral area if leg and feet joints are painful.

↳ 10 Hz

:S: ▲

10–15 min. 2–3 times a day

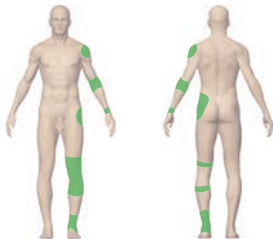

■ Painful area
■ Unaffected side

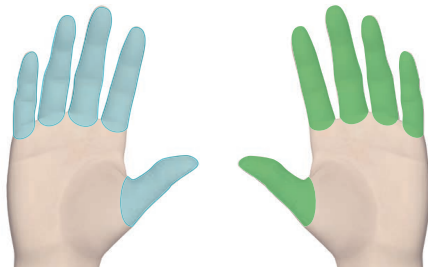

Additional zones

1. Symmetrical unaffected joint

↳ 10 Hz

LS



5–10 min. 1–2 times a day

2. Area according to Su Jok

↳ 77 Hz

S



5 min. 1–2 times a day

Note. Course duration — until recovery but for a minimum of 7 days.



Neck pain and backache

(vertebral osteochondrosis, diskogenic radiculopathy, lumbodynia, ischias)

Main zones

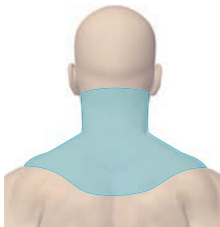

1. Cervical spine if there is neck pain

↳ 77 Hz, 140 Hz

LS

5–30 min. 1–2 times a day



— intense pain



— dull nagging ache

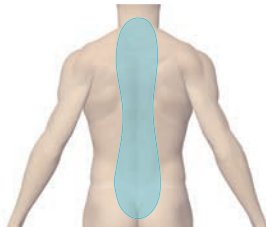

2. Thoracic, lumbar, and sacral spine areas if there is backache

↳ 77 Hz, 140 Hz

LS

5–30 min. 1–2 times a day



— intense pain



— dull nagging ache

Neck pain and backache

(vertebral osteochondrosis, diskogenic radiculopathy, lumbodynia, ischias)



163

Additional zones

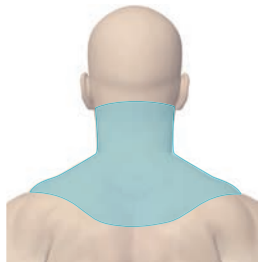

1. Neck and collar area

↳ 9,6 Hz



5–15 min. 1–2 times a day

Note. Course duration — until recovery.

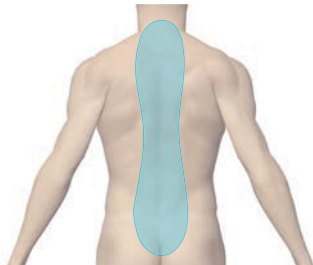

2. Pain center projection

↳ 9,6 Hz



5–15 min. 1–2 times a day

EN



Micro-ruptures (tension) of ligaments, tendons, and muscles, joint dislocations, meniscus injuries

Main zones

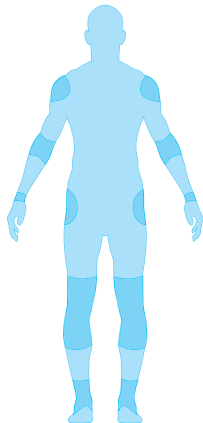

1. Direct projection of injured area (painful area, nascent edema)

↳ 77 Hz

S

5-30 min.



— intense pain



— dull nagging ache

Several times a day as the patient's complaints increase.



1. Neck and collar area if upper limbs are injured

↳ 10 Hz



10–15 min. 1–2 times a day



2. Lumbosacral area if lower limbs are injured

↳ 10 Hz, «7710»



10–15 min. 1–2 times a day

Note. Course duration — until full recovery.

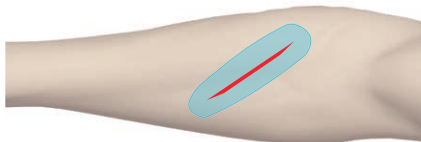

1. Area around the wound

↳ 77 Hz

S 5–30 min. 3–4 times a day



— intense pain



— dull nagging ache, painless

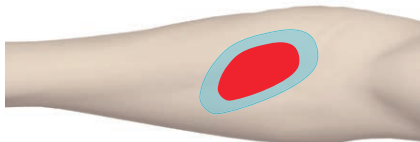

2. Burnt wound

↳ 77 Hz

S 5–30 min. 3–4 times a day



— intense pain



— dull nagging ache, painless

Note. Stimulate area around the burnt wound.



1. Neck and collar area

↳ 10 Hz



10–15 min. 1–2 times a day

Note. Course duration — until full recovery.



2. Lumbosacral area

↳ 10 Hz, «7710»



10–15 min. 1–2 times a day

Nephrocolica, frequent and painful urination (pyelonephritis, cystitis, urethritis)

Main zones

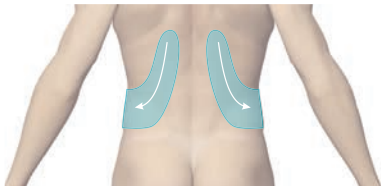

1. Direct projection of kidneys and ureters (body back surface)

↳ 77 Hz

S 5–30 min. 1 time a day

 — intense pain

 — dull nagging ache, painless

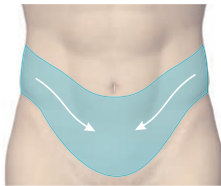

2. Direct projection of kidneys and ureters (body front surface)

↳ 77 Hz

S 5–30 min. 1 time a day

 — intense pain

 — dull nagging ache, painless

Note. In case of complaints conduct treatment 3–4 times a day until there is improvement, then continue once a day.

Nephrocolica, frequent and painful urination (pyelonephritis, cystitis, urethritis)



169



1. Neck and collar area

↳ 10 Hz



10–15 min. 1–2 times a day

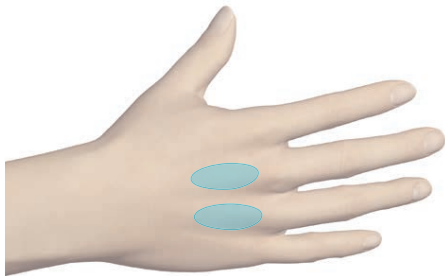

2. Area according to Su Jok

↳ 77 Hz



5 min. 1–2 times a day

Additional zones

Note. Course duration — for a minimum of 10–12 days.

EN

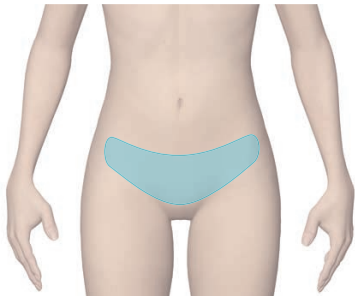

1. Pubic area (lower abdomen)

↳ 77 Hz

LS



5–10 min.

1 time a day



2. Lumbosacral area

↳ 10 Hz

:S:



10–15 min.

1 time a day

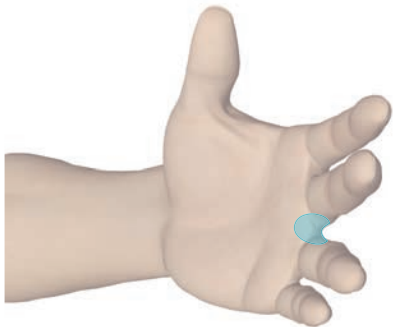

1. Area according to Su Jok

↳ 77 Hz

S



5 min.

1

time
a day

Note. Course duration – 14 days. Repeat the course in a month.



Lower abdominal pain

(algodismenorrhea, inflammatory diseases of female reproductive organs)

Main zones



1. Pubic area (lower abdomen)

↳ 77 Hz

LS



5–10 min. 2–3 times a day

2–3 times a day when there is pain



2. Lumbosacral area

↳ 10 Hz

:S:



10–15 min. 2–3 times a day

2–3 times a day when there is pain

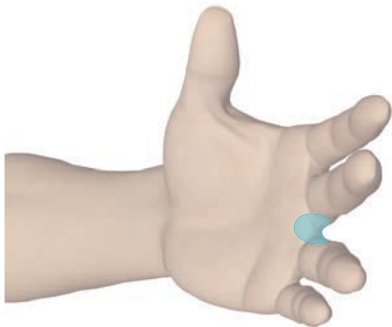

1. Area according to Su Jok

↳ 77 Hz

S



5 min.

1-2 times
a day

Note. Course duration – 10-14 days.

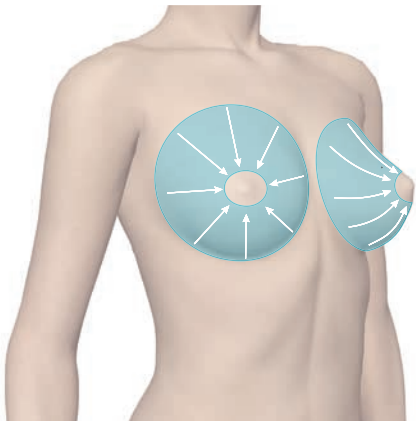
**1. Direct projection of mammary glands**

↳ 77 Hz

LS**20-30 min.**

Several times a day before breast-feeding.



1. Thoracic section (at mammary glands level)

↳ 77 Hz, 10 Hz

:S:  10–15 min.

Several times a day before breast-feeding.

Note. Course duration — until full recovery.

Lower abdominal pain and genitals pain (prostatitis, urethritis, orchitis, algodismenorrhea)

Main zones

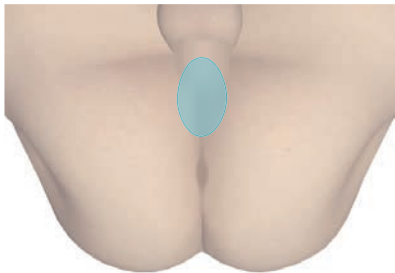

1. Perineum area

↳ 77 Hz

S  5–10 min. 3–4 times a day

3–4 times a day when there is pain.



2. Lumbosacral area

↳ 10 Hz

:S:  10–15 min. 3–4 times a day

3–4 times a day when there is pain.

Lower abdominal pain and genitals pain (prostatitis, urethritis, orchitis, algodismenorrhea)



177

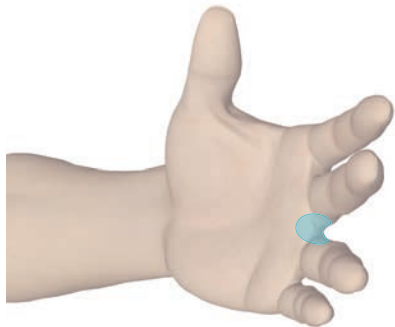

1. Area according to Su Jok

↳ 77 Hz

S



5 min.

1-2 times
a day

Additional zones

Note. Course duration — until full recovery.

EN

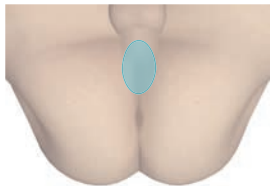

1. Perineum area

↳ 77 Hz

S



5–10 min. 1 time a day



2. Pubic and groin areas

↳ 9,4 Hz

S



5 min. 1 time a day



3. Lumbosacral area

↳ 10 Hz

:S:



10–15 min. 1 time a day

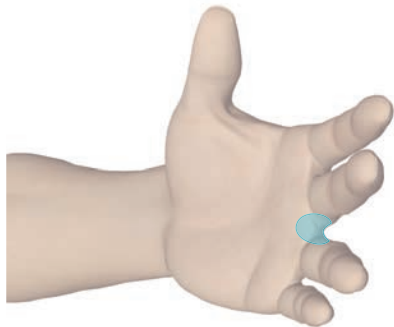

1. Area according to Su Jok

↳ 77 Hz

S



5 min.

1

time
a day

Additional zones

Note: Course duration — for a minimum of 10–14 days. Repeat the course in a month.

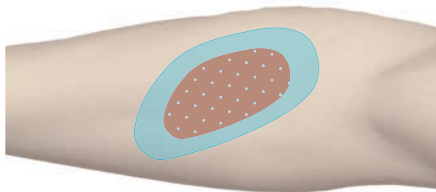

1. Affected skin parts

↳ 77 Hz

S



5–10 min. 1 time a day

3–4 times a day in case of intense itching.

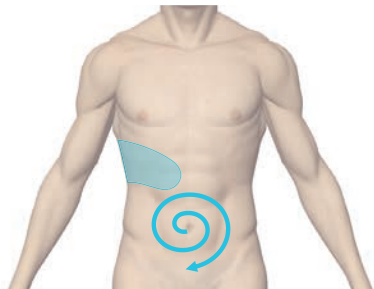

2. Liver and intestines area

↳ 77 Hz

LS



5–10 min. 1 time a day

3–4 times a day in case of intense itching.

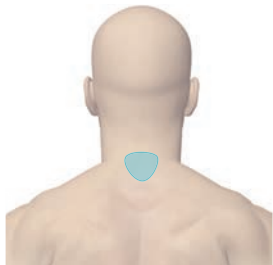

1. 7th vertical vertebra area

↳ 1,7 Hz

S  **5 min.** **1** time a day

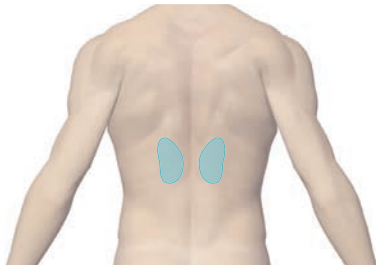

2. Adrenal glands area

↳ 1,7 Hz

S  **5 min.** **1** time a day

Note: Course duration — for a minimum of 10–14 days. Repeat the course in 1-1.5 months.

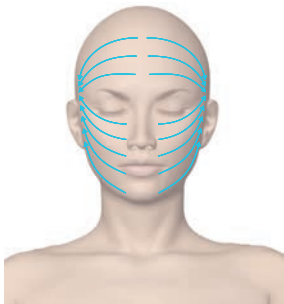

1. Facial skin according to cosmetic lines

↳ 77 Hz

S



5-10 min. 1 time a day



2. Submaxillary area

↳ 77 Hz

S



5-10 min. 1 time a day

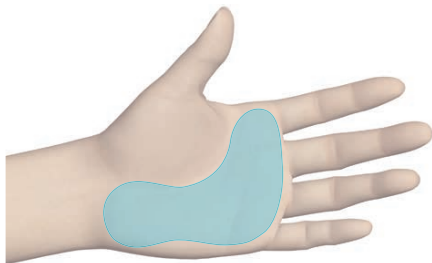

1. Liver and intestines area according to Su Jok

↳ 77 Hz

S



5 min.

1

time
a day



2. Neck and collar area

↳ 10 Hz

:S:



10-15 min.

1

time
a day

Note: Conduct sessions 3 times a week. Course duration — 12–15 treatments.

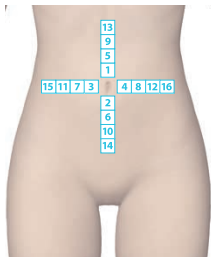

1. Abdominal area ("cross")

↳ 77 Hz

S



30-60 s. **1** time a day



2. Buttock area

↳ 77 Hz

L



5-10 min. **1** time a day



3. Thighs

↳ 77 Hz

L



5-10 min. **1** time a day

Note: 30-60 sec. per each application of electrodes.



1. Appetite suppressing point

↳ 10 Hz

S



3–5 min.

1

time
a day



2. Neck and collar area

↳ 10 Hz

:S:



5–10 min.

1

time
a day

Note: Course duration — 10–14 days. Repeat the course in 1–2 months.



1. Neck and collar area

↳ 10 Hz

S  5-10 min.



2. 2nd cervical vertebra area and occipital protuberance area

↳ 10 Hz

S  5 min.



3. Direct projection of painful area in case of headache

↳ 9,0 Hz

S  5-10 min.

Until the pain is relieved or once a day during course treatment.



1. Area according to Su Jok

↳ 9,0 Hz

S  5 min. 1 time a day

Note: Course duration — 10 days.



2. Lumbosacral area

↳ 10 Hz

:S:  10–15 min. 1 time a day

☀ Face pain (trifacial neuralgia, Bell's palsy)

Main zones

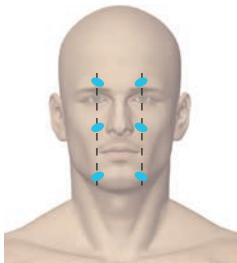

1. Trigeminus branches output points

↳ 77 Hz

S



2-3 min.

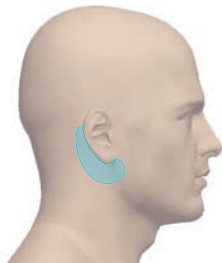

2. Area under earlobe

↳ 77 Hz

S



2-3 min.



3. Neck and collar area

↳ 10 Hz

:S:



10 min.

Until the pain is relieved or once a day during course treatment.



1. Area according to Su Jok

↳ 9,0 Hz

S



5 min.

1 time
a day

Additional zones

Note: Course duration — 10 days.



1. Submaxillary and speech areas

↳ 77 Hz

S



5-10 min. 1 time a day



2. Neck and collar area

↳ 10 Hz

:S:



5-10 min. 1 time a day



1. Area according to Su Jok

↳ 10 Hz

S



5–10 min.

1

time
a day

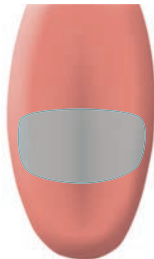

2. Tongue

↳ 77 Hz

S



30–60 s.

1

time
a day

Note: Course duration — 10 days. Repeat the course in a month.

For children below 5 year of age: intensity — , stimulation time of each zone (except for tongue) — 2–3 min.

**1. Neck and collar area**

↳ 77 Hz, «7710»

:S:  5-10 min. 1-2 times a day

Conduct treatment in the morning and/or in the evening.

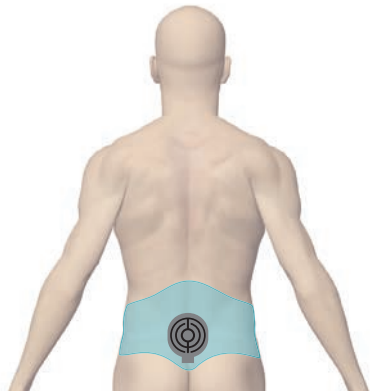

Note: Course duration — 5–10 days.

2. Lumbosacral area

↳ 10 Hz

:S:



10–15 min. 1–2 times a day

Conduct treatment in the morning and/or in the evening.

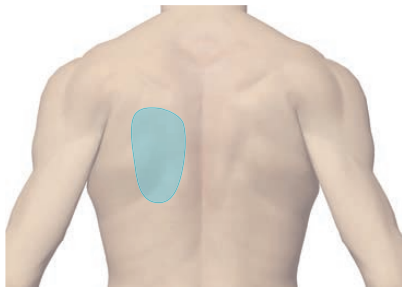

1. Back projection of heart

↳ 77 Hz

S  5-10 min.

Until complaints decrease / stop.

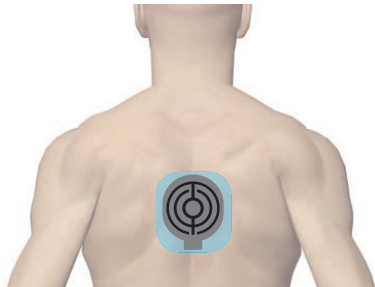

2. Area between the shoulder blades

↳ 10 Hz

:S:  10 min.

Until complaints decrease / stop.

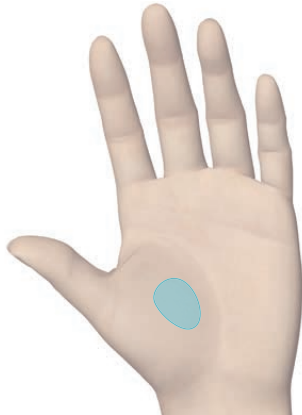

1. Area according to Su Jok

↳ 10 Hz

S



5–10 min.

Until complaints decrease / stop.

♥ Arterial hypertension (hypertensive disease)

Main zones



1. Neck and collar area

↳ 10 Hz



5-10 min. 1 time a day



2. 2nd cervical vertebra area and occipital protuberance area

↳ «7710»



5 min. 1 time a day



1. Area according to Su Jok

↳ 9,2 Hz



5 min.

1 time a day

Note: Course duration — 10 days.



2. Lumbosacral area

↳ 10 Hz



10–15 min. 1 time a day



1. 2nd cervical vertebra area and occipital protuberance area

↳ «77AM»



5 min.

1 time a day



2. Neck and collar area

↳ 10 Hz



5-10 min.

1 time a day



1. Area according to Su Jok

↳ 9,2 Hz

S  5 min. 1 time a day

Note: Course duration — 10 days.



2. Lumbosacral area

↳ 10 Hz

:S:  10-15 min. 1 time a day

♥ Heavy legs, edema, varicose veins (chronic venous insufficiency syndrome, varicose lower limbs disease)

Main zones



1. Shins and feet area (from toes to knees)

↳ 77 Hz

L



10–15 min. 1 time a day

Attention! It is prohibited to apply the electrodes of the device on shins in direct projection of the modified veins (varicose, tortuous veins).



2. Lumbosacral area

↳ 10 Hz

:S:



10–15 min. 1 time a day

Heavy legs, edema, varicose veins

(chronic venous insufficiency syndrome, varicose lower limbs disease)



201



1. Area of liver projection

↳ 77 Hz

S



5–10 min.

1

time
a day

Once a day or once in two days

Additional zones

Note: Course duration — 2–3 weeks. Repeat the course in 1–2 months.

EN

♥ **Leg pain, intermittent lameness** (lower limbs atherosclerotic vascular disease),
diabetic angiopathy, vibration syndrome (Peripheral arterial diseases)

Main zones



1. Shins and feet area (from toes to knees)

↳ 77 Hz



10–15 min. 1 time a day

Attention! It is prohibited to apply the electrodes of the device on shins in direct projection of the modified veins (varicose, tortuous veins).



2. Lumbosacral area

↳ 10 Hz



10–15 min. 1 time a day

Leg pain, intermittent lameness (lower limbs atherosclerotic vascular disease),
diabetic angiopathy, vibration syndrome (Peripheral arterial diseases) 

203

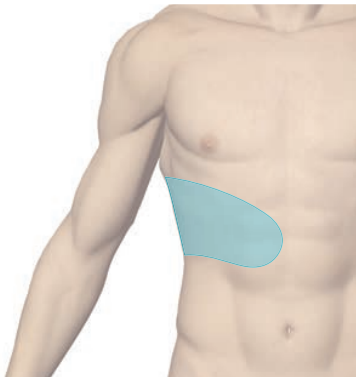

1. Area of liver projection

↳ 77 Hz

S



5–10 min.

1

time
a day

Once a day or once in two days

Additional zones

Note: Course duration — 2–3 weeks. Repeat the course in 1–2 months.

EN

 **Eye overstrain, refringence disorder** (astigmatism, spasm of accommodation, short sight, long sight), **glaucoma, cataract, inflammatory eye conditions**



1. Paraorbital area

↳ 77 Hz



10 min.

1-2 times a day



2. Neck and collar area

↳ 10 Hz, «7710»



10-15 min. 1-2 times a day

Eye overstrain, refringence disorder (astigmatism, spasm of accommodation, short sight, long sight), **glaucoma, cataract, inflammatory eye conditions**



205



1. Area according to Su Jok

↳ 77 Hz

S



5–10 min.

1

time
a day

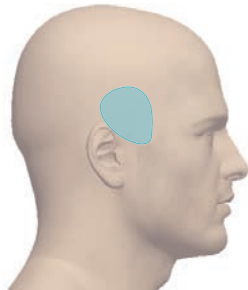

2. Temporal region

↳ 77 Hz

S



5 min.

1

time
a day

Additional zones

Note: Course duration — 10–14 days. Repeat the course in 1–2 months.

EN



1. Skin projection of painful tooth or inflamed mucous membrane of mouth cavity in case of stomatitis

↳ 77 Hz

S  **10–20 min. 2–3 times a day**

Until the pain is relieved.

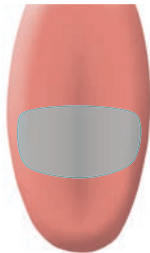

2. Tongue

↳ 77 Hz

S  **1–2 min. 2–3 times a day**

Until the pain is relieved.



1. Area according to Su Jok

↳ 77 Hz

S



5-10 min.

2-3 times a day

Additional zones

**1. Neck and collar area**

↳ 10 Hz

:S: 

10 min.

1 time
a day



1. Area according to Su Jok

↳ 77 Hz

S



5–10 min.

1

time
a day

Note: Course duration — 10–14 days.
In case of chronic disease repeat the course in 1–2 months.

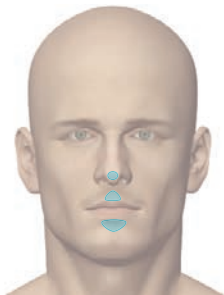

1. Facial Reanimation points

↳ 77 Hz

S  **30 sec.** per each point

One time.

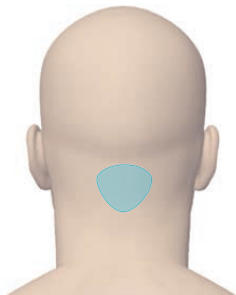

2. 2nd cervical vertebra area

↳ 77 Hz

S  **2-3 min.**

One time.

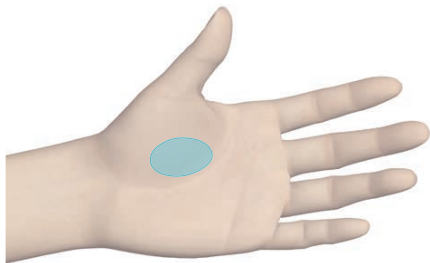

1. Area according to Su Jok

↳ 77 Hz

:S: 

1-2 min.

One time.



2. Neck and collar area

↳ 10 Hz

:S: 

5-10 min.

One time after a faint.

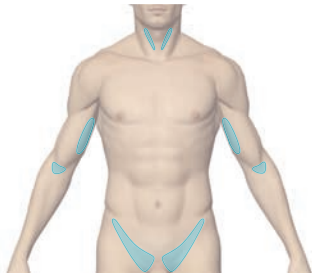

1. Projection of carotid, brachial, ulnar and femoral arteries

↳ 77 Hz

S  **30 sec.** per each point

One time.



2. Forehead area and temporal regions

↳ 77 Hz

S  **2-3 min.**

One time.



1. Forearms area (bracelet)

↳ 77 Hz



1 min.

One time.



2. Neck and collar area

↳ 10 Hz



5-10 min.

One time.

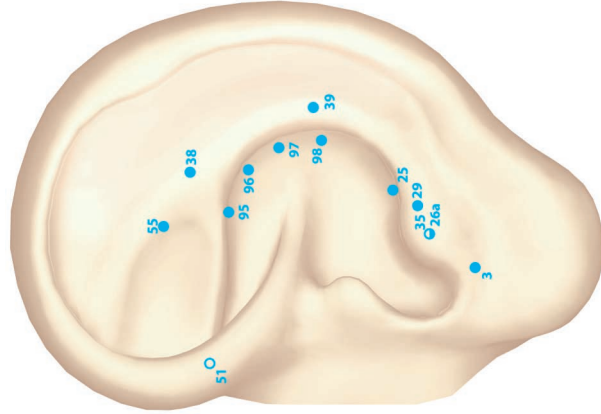

General pain relief. Points of auricle

↳ 77, 20 Hz



1-2 min.

Treat 1-2 pairs of points during one session.

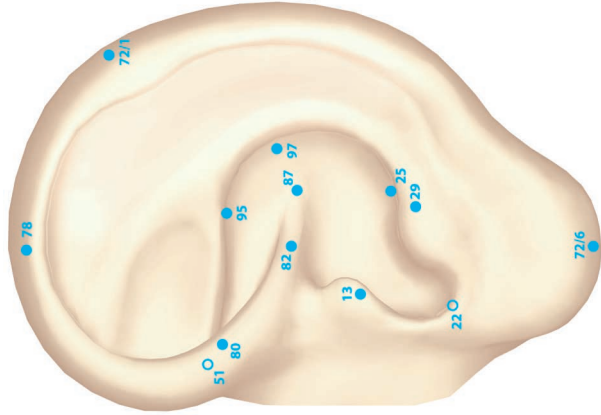

**Inflammation.
Pointes of auricle.**

↳ 77 Hz



1-2 min.

Treat 1-2 pairs of points during one session.

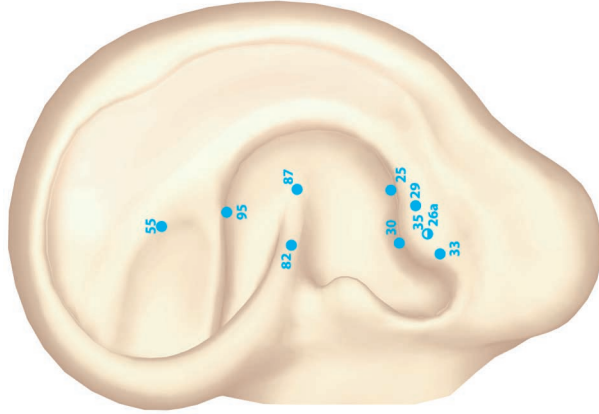

Headache.
Pointes of auricle.

↳ 77, 20 Hz

S 

1-2 min.

Treat 1-2 pairs of points during one session.